

➤ Instructions

Thule Excellence XT

611905, 611906, 611907

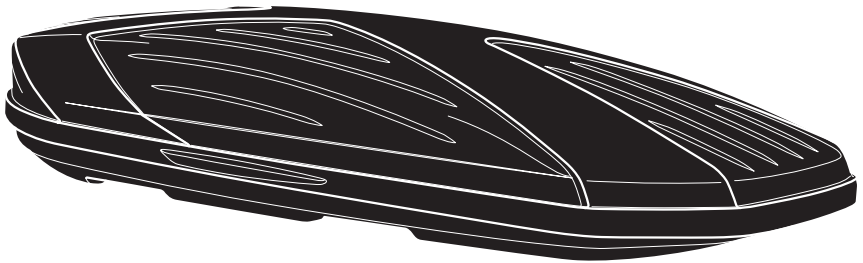

THULE.COM

- EN** Roof box for roof-mounted racks
DE Dachbox für Dachträger
FR Coffre pour barres de toit
NL Dakkoffer
IT Box da tetto per portapacchi da installare sul tetto
ES Cofre portaequipajes para barras de techo
PT Caixa bagageira para barras de tejadilho
SV Takbox för takmonterade räckor
DK Tagboks til tagbøjler
NO Takboks til takmonterte stativer
FI Katolle asennettaviin telineisiin sopiva kuljetuslaatikko
ET Katusele paigaldatav katuseboks
LV Jumta kaste uz jumta uzstādāmiem bagāžniekiem
LT Ant stogo tvirtinamų skersinių bagažinės
PL Box dachowy na bagażnik montowany na dachu
RU Грузовой бокс на крышу автомобиля
UK Вантажний бокс для багажників для даху
BG Кутия за багаж за релси, монтирани върху покрива
CS Střešní box pro montáž na střechu

- SK** Strešný box na strešné nosiče
SL Strešni kovček za strešne prtljažnike
HR/BIH Krovna kutija za krovne nosače
RO Portbagaj de acoperiș pentru cadru de bare montate pe acoperiș
HU Tetőre szerelhető tetőbox
EL Μπαγκάζιέρα οροφής για μπάρες οροφής
TR Araç üstüne bağlanan raflar için tavan kutusu
HE תא חפצים ללג הרכב
AR صندوق سقف للحوامل المثبتة على السقف
ZH 用于车顶架的车顶箱
JA ルーフマウント型ラック用ルーフボックス
KO 루프 장착 랙 루프 박스
TH กล่องบนหลังคาสำหรับแร็คหลังคา



CITY CRASH
 Complies with ISO norm

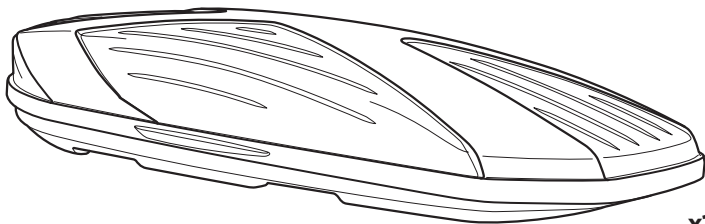
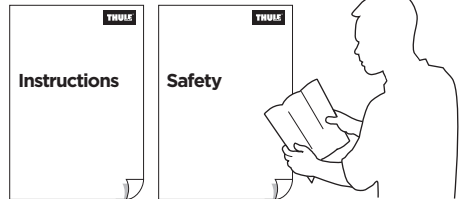

x1

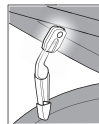

x1



x1



x1



x3



x2

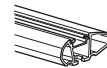

Thule WingBar Evo

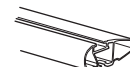

Thule WingBar/
Thule AeroBlade

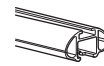

Thule AeroBar

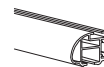

Thule ProBar Evo



Thule SlideBar Evo



Thule SquareBar Evo

i

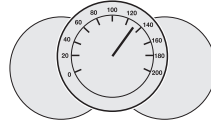
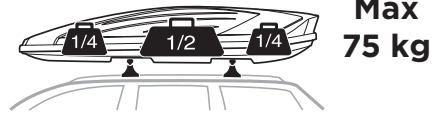

Max 130 km/h

	Weight	Volume
Excellence XT	28 kg	470 litre

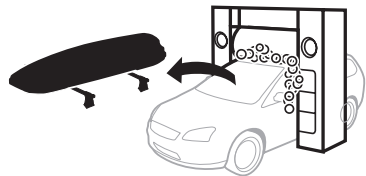
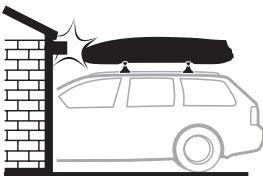
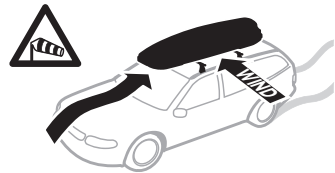
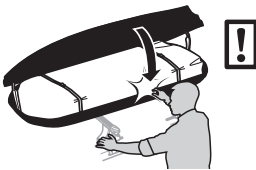
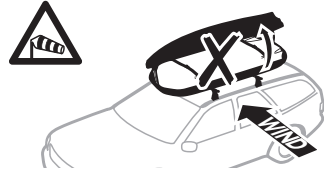
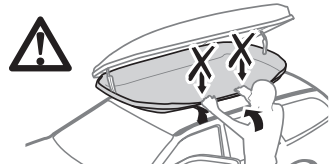
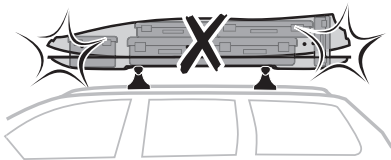

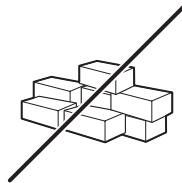
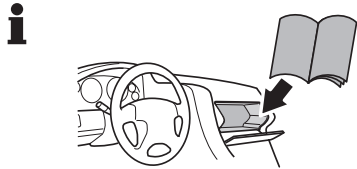
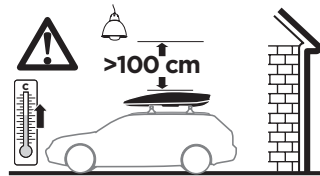
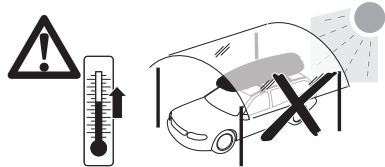
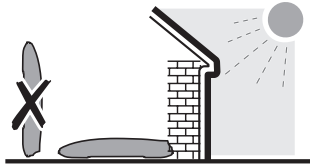

i

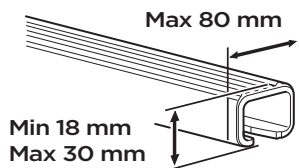
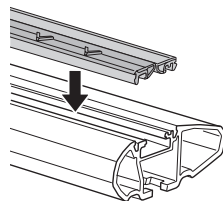
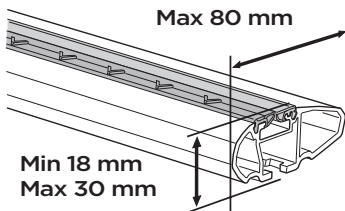

Thule T-track Adapter

696600

697600

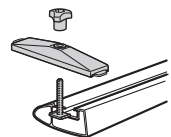

i

		D Min	D Max	W in	W out	H	L	R Min
<i>Excellence XT</i>	mm	555	935	756	830	360	2180	1290

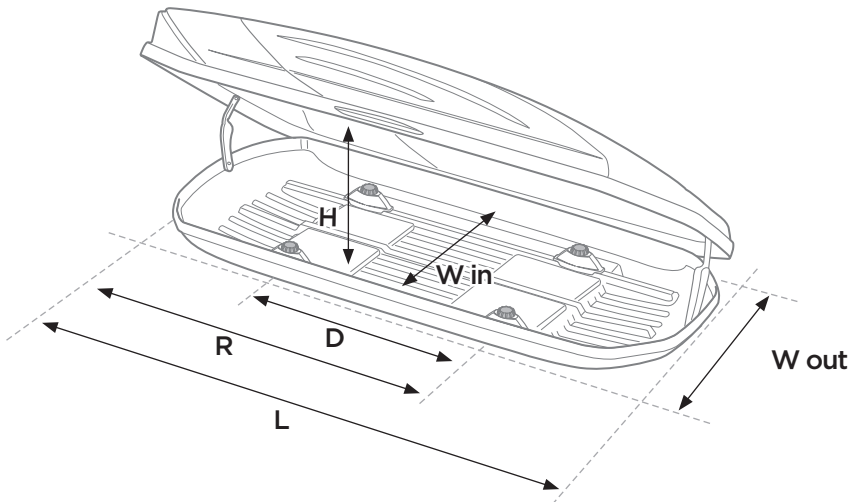
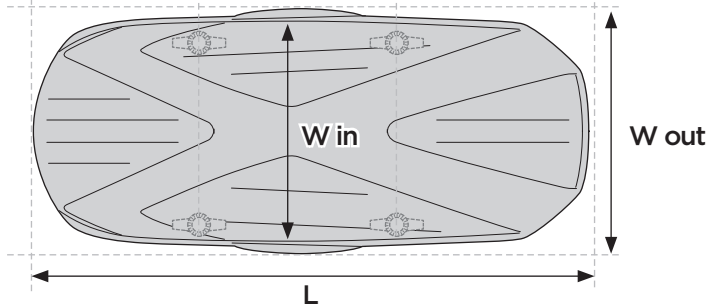
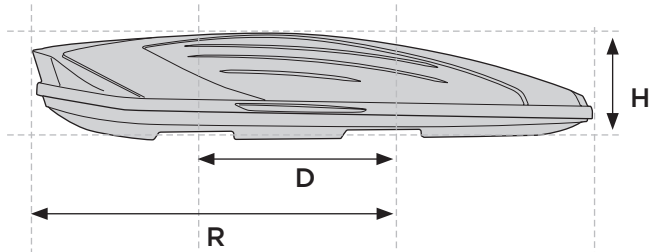

1

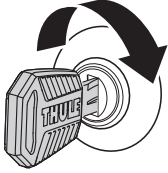
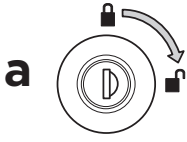

b

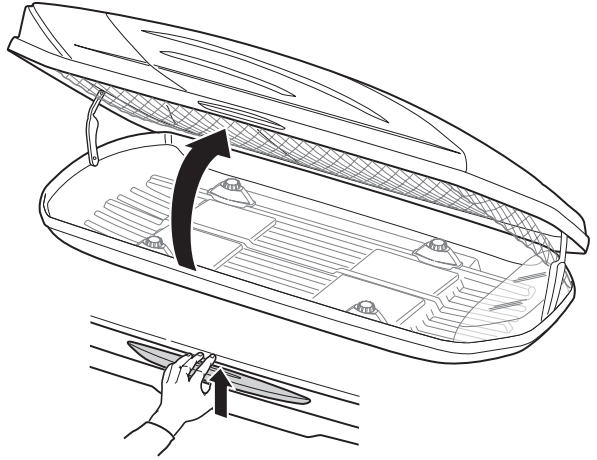

2

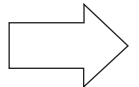
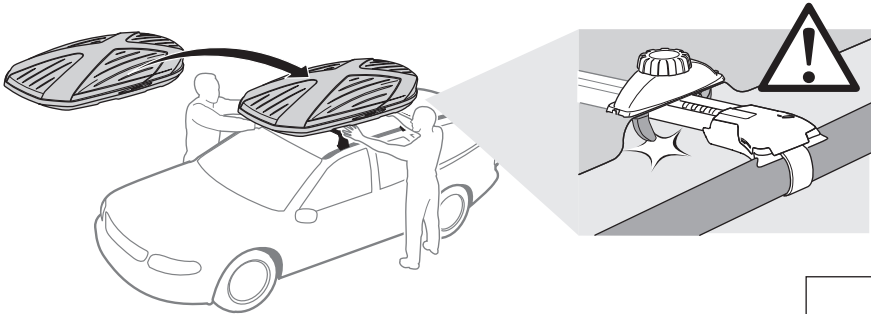
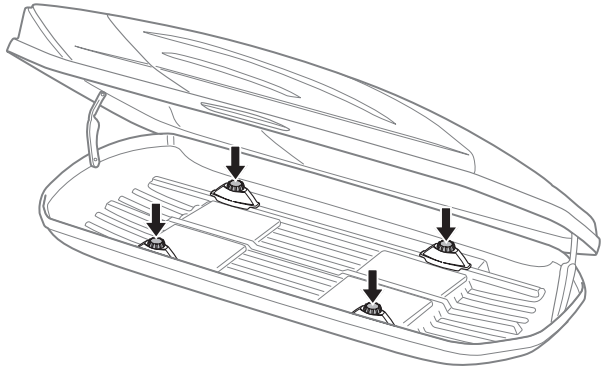
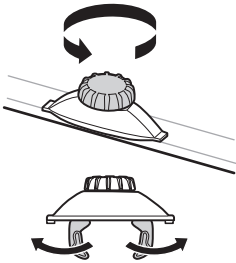

3

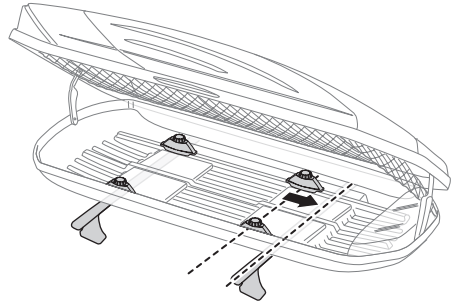
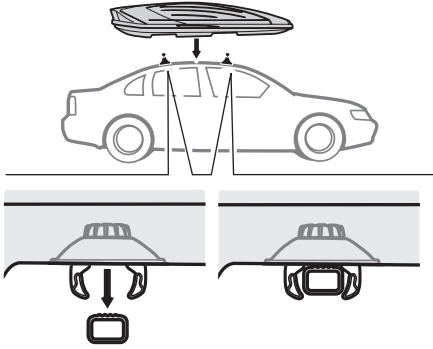
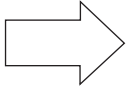

4

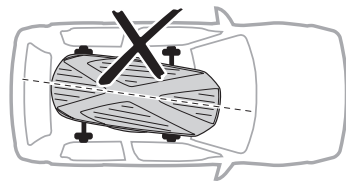
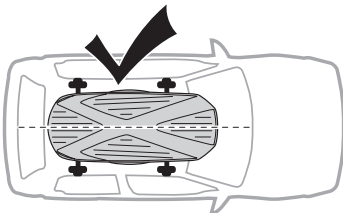
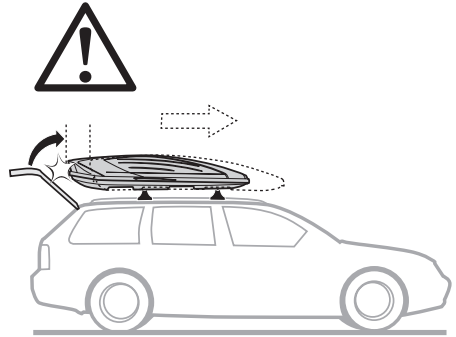

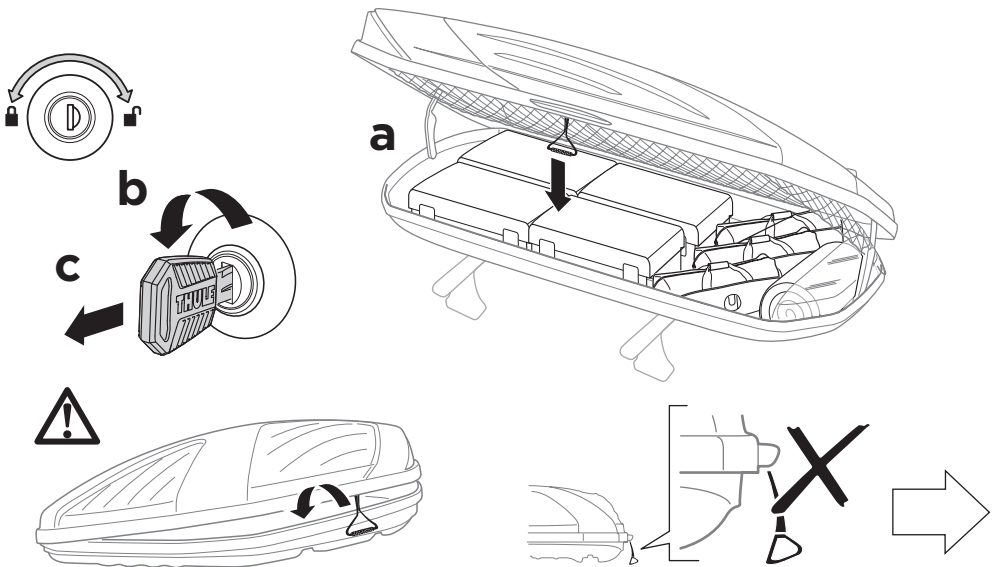
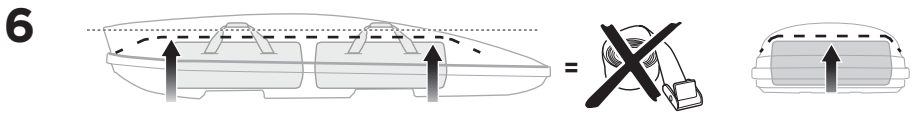
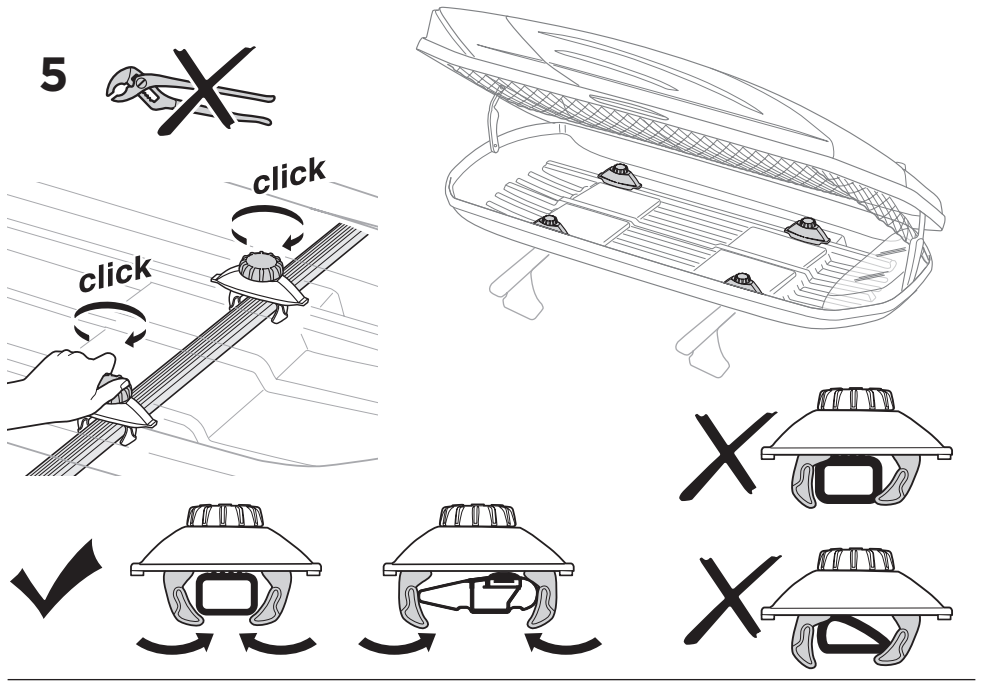

6
→

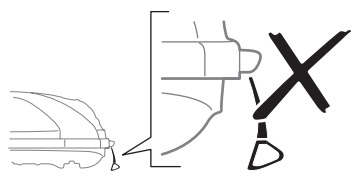
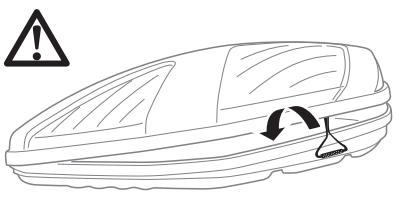
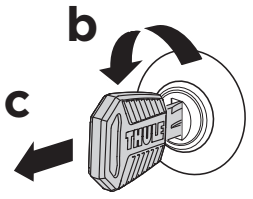
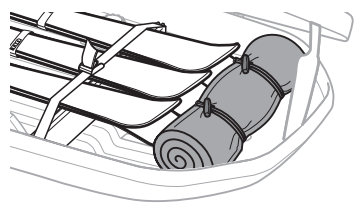
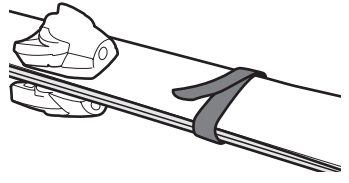
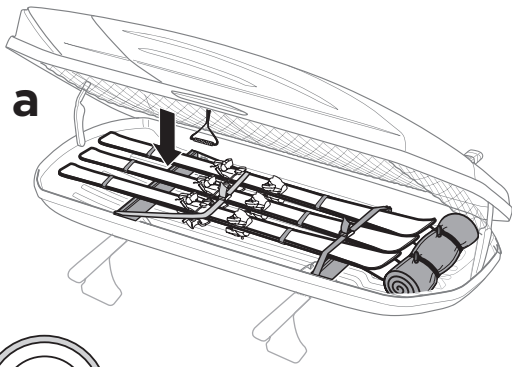
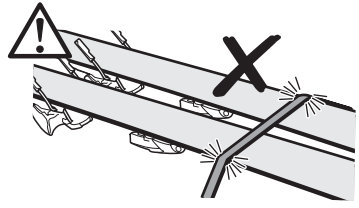
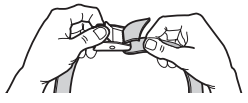
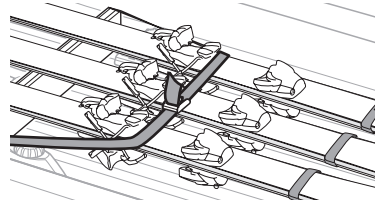
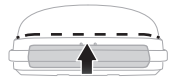
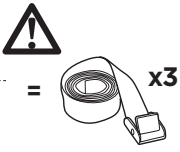
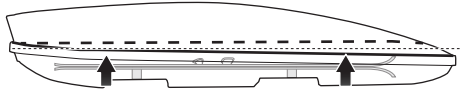

i

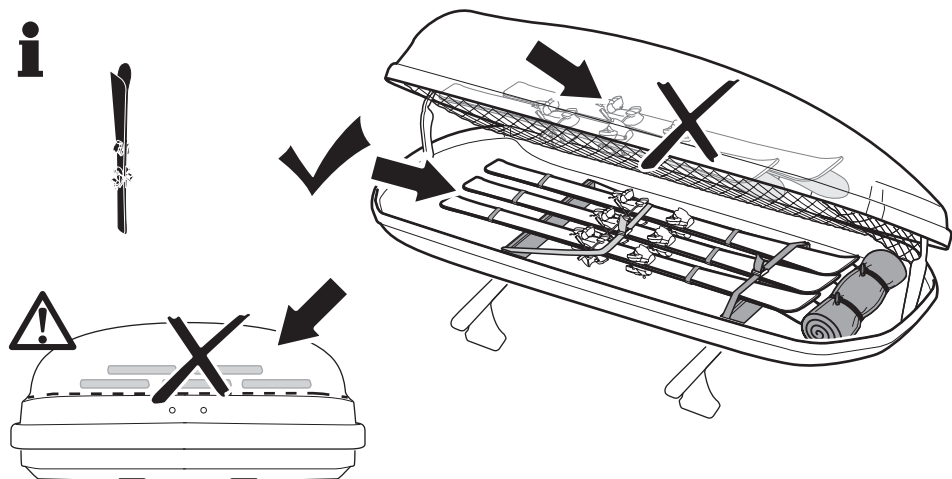

7

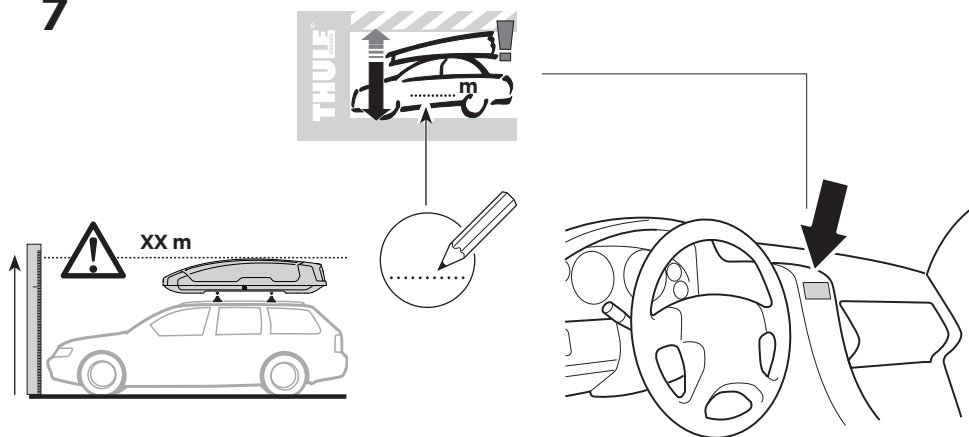

8

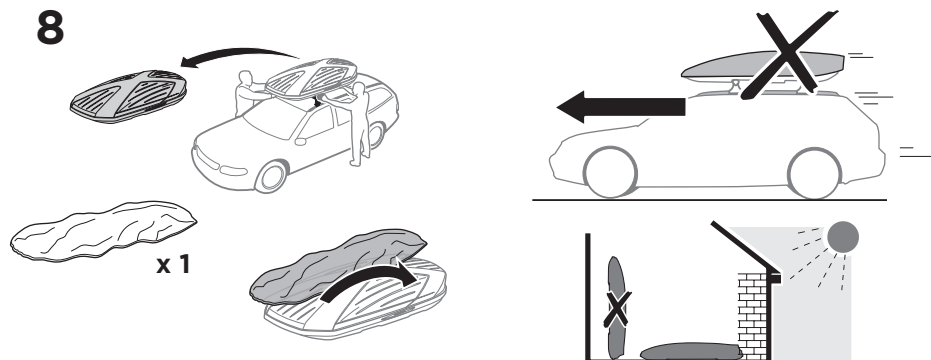

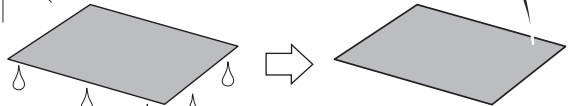
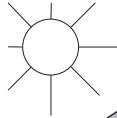
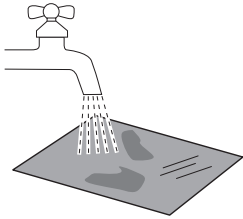
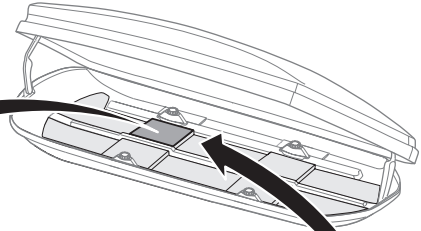
i**EN** Accessories**DK** Tilbehør**UK** Аксессуары**EL** Εξαρτήματα**DE** Zubehör**NE** Tilbehør**BG** Принадлежности**TR** Aksesuarlar**FR** Accessoires**FI** Lisävarusteet**CS** Doplňky**AR** الملحقات**NL** Accessoires**ET** Lisavarustus**SK** Príslušenstvo**HE** אביזרים**IT** Accessori**LV** Piederumi**SL** Dodatki**ZH** 附件**ES** Accesorios**LT** Priedai**HR/BiH** Dodaci**JA** アクセサリー**PT** Acessórios**PL** Akcesoria**RO** Accesorii**KO** 액세서리**SV** Tillbehör**RU** Аксессуары**HU** Tartozékok**TH** อุปกรณ์เสริม

Thule T-track Adapter

696600

24x30 mm

697600

20x27 mm

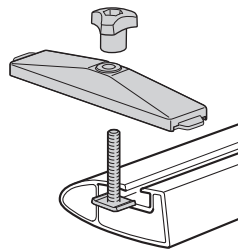

20 / 24

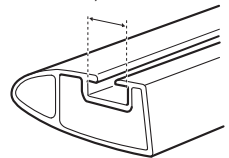

Thule Box Ski Carrier Adapter

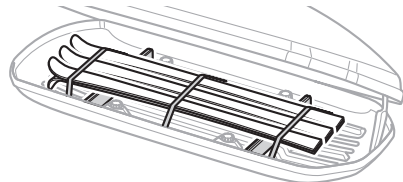
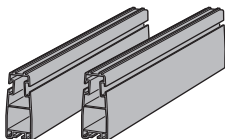
694900

Thule MultiLift

572004

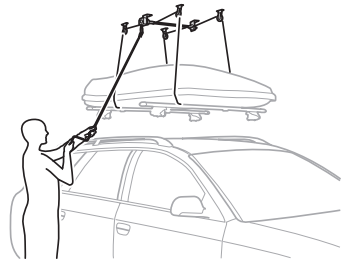
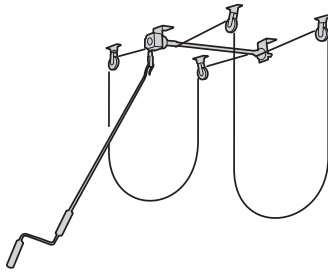

Thule One-Key System

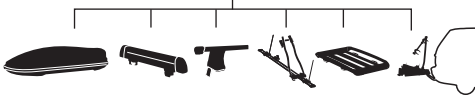

450400  (x4)

450600  (x6)

450800  (x8)

451200  (x12)

451600  (x16)

