



CONTROLLED

RHINO-RACK

RCP05-BK Range Rover Pad Kit

Important: Please read these instructions carefully prior to installation. Please refer to your fitting instruction to ensure that the roof racks are installed in the correct locations. Check the contents of kit before commencing fitment and report any discrepancies

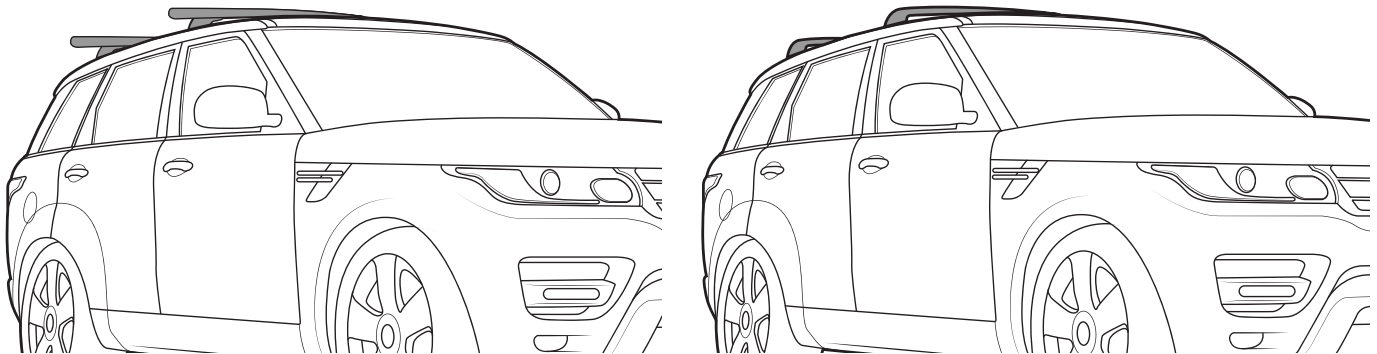

Note: Crossbars and legs sold as separate.

Important Information

1. Check Part No./Kit is correct
2. Read through instruction before installing
3. Fit roof rack accessory
4. Check and recheck all fasteners are secure

Maximum carrying capacity: 100kg/ 220lbs. Note: Be sure to check the Rhino-Rack website to see if you have the latest version of instructions before beginning installation.

Recommendations

It is essential that all bolt connections be checked after driving a short distance when you first install your crossbars. Bolt connections should be checked again at regular intervals (probably once a week is enough, depending on road conditions, usage, loads and distances travelled). You should also check the roof bars each time they are refitted. Make sure to fasten your load securely. Please ensure that all loads are evenly distributed and that the centre of gravity is kept as low as possible. **Use only non-stretch fastening ropes or straps.**

Sensitivity to Crosswinds, Behaviour in Curves and Braking

The handling characteristics of the vehicle, changes when you transport a load on the roof. For safety reasons, we recommend you exercise extreme care when transporting wind-resisting loads; special consideration must be taken into account when braking. **Please remove crossbars when putting vehicle through an automatic car wash.**

Load Ratings

Maximum permissible load is 100kg per pair of roof racks (include the weight of the roof bars, 5kg). When roof racks are to be used in off-road conditions, please build a safety factor of 1.5 into this load limit (66ks/145lbs). Although the roof racks are tested and approved to AS1235-2000, Australian road conditions can be much more rigorous. However, increasing the number of crossbars does not increase the vehicles maximum permissible roof loading.

Note for Dealers and Fitters

It is your responsibility to ensure instructions are given to the end user or client

Rhino-Rack

3 Pike Street, Rydalmere,

NSW 2116, Australia.

(Ph) (02) 9638 4744

(Fax) (02) 9638 4822

Document No: R1308

Prepared By: Kayle Everett

Authorised By: Chris Murty

Fit Time: 30min

Issue No: 02

Issue Date: 11/04/2018

These instructions remain the property of Fetovu Pty Ltd T/as Rhino-Rack and may not be used or changed for any other purpose than intended.



RCP05-BK Range Rover Pad Kit

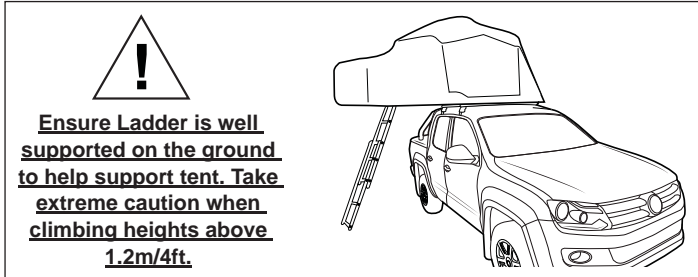
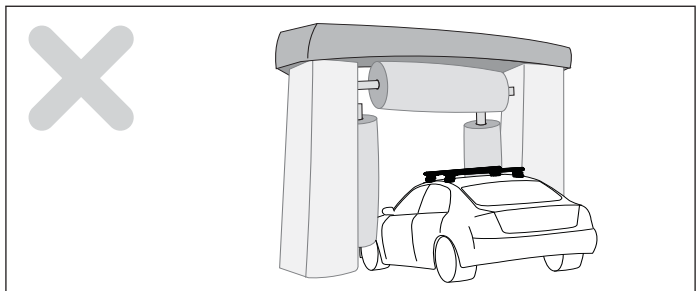
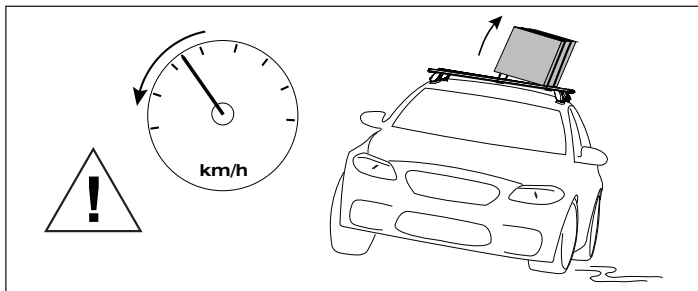
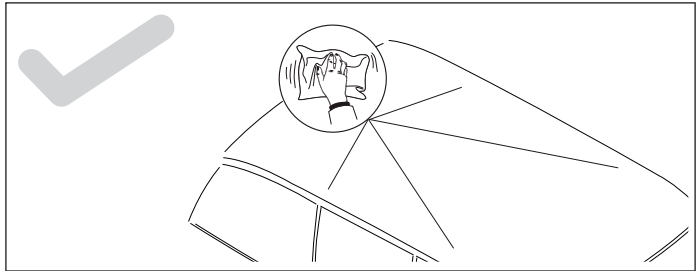
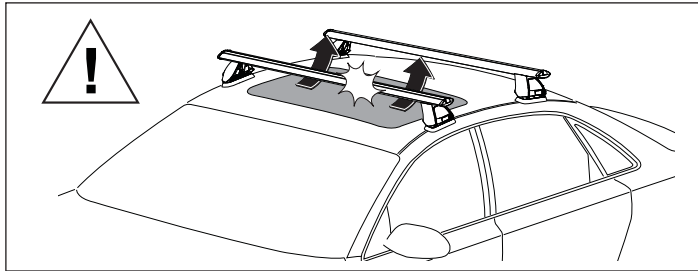
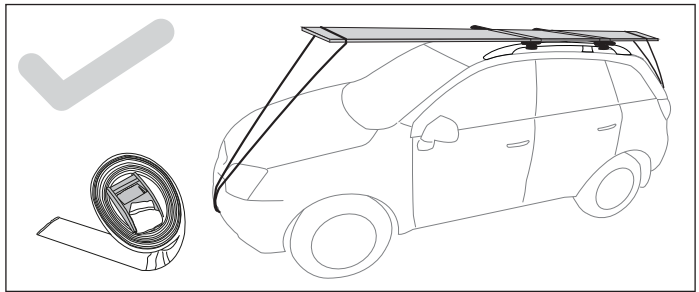
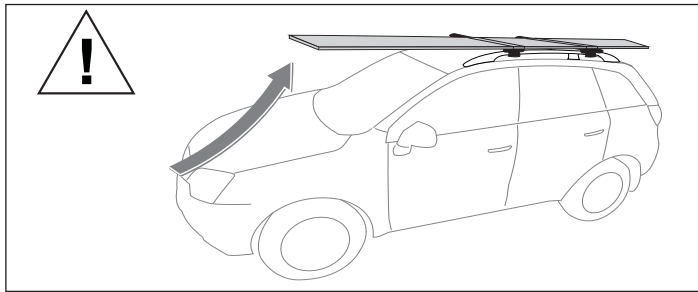

Ensure Ladder is well supported on the ground to help support tent. Take extreme caution when climbing heights above 1.2m/4ft.

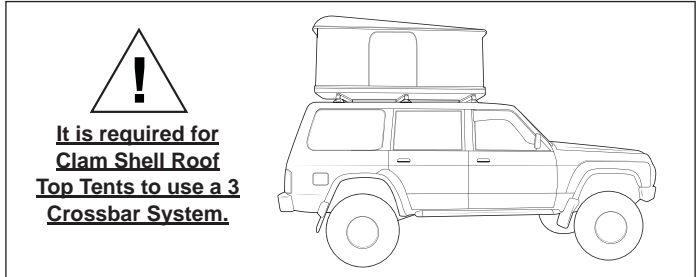

It is required for Clam Shell Roof Top Tents to use a 3 Crossbar System.

When these roof racks are to be used on a vehicle that is driven off sealed roads the maximum load rating must be divided by 1.5. Remember to subtract the weight of the roof racks to determine your maximum permissible load capacity.

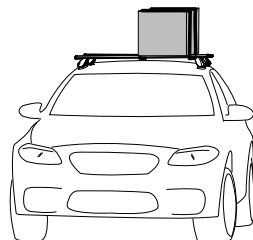

2 bars 100kg (220lbs) load rating (Urban road) = 2 bars 66kg (145lbs) load rating (Off road)
Load rating not taking into account crossbar weight - 5kg

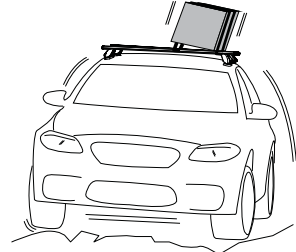

WARNING! Important Load Carrying Instructions

With utility vehicles, the cabin and the canopy move independently. Roofracks and vehicle can be damaged if the item transported is rigidly fixed at points on both the cabin and canopy. Instead, rigidly fix to either the cabin roofracks or the canopy roofracks.

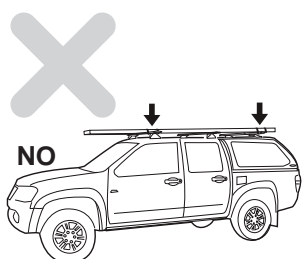

NO

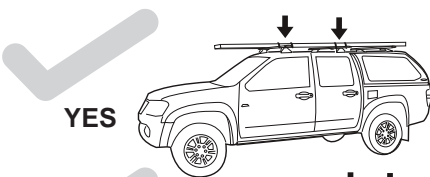

YES

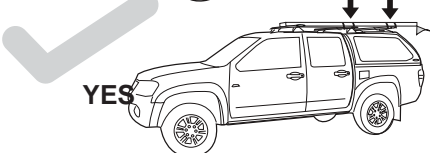

YES

Paddle/ Surfboards should be fixed to the front of the vehicle.

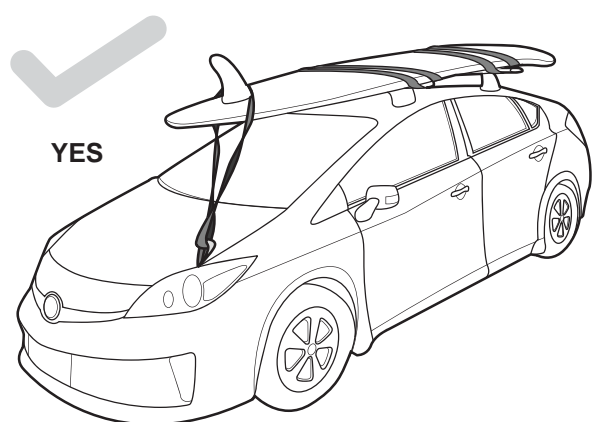

YES



RCP05-BK Range Rover Pad Kit

Parts List

Item	Component Name	Qty	Part No.
1	M6 x 50mm Hex Setscrew	4	B134
2	M6 x 35mm Hex Setscrew	2	B203
3	M6 Spring Washer	6	W004
4	M6 x 16mm Flat Washer	6	W031
5	Mounting Stud	6	C358
6	Range Rover Mounting Pad Centre	2	M166
7	Range Rover Mounting Pad Middle	2	M167
8	Range Rover Mounting Pad Rear	2	M168
9	Mounting Pad Cover Plate	6	M126
10	M6 Washer (used on cover plate)	6	W003
11	Instruction	1	R1308

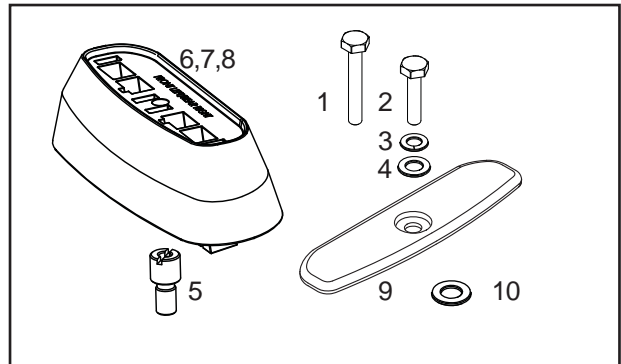

Tools Required

Phillips head screwdriver. 10mm socket wrench
Flat bladed screwdriver.

Instructions

- 1** From the top of the vehicle, fold open each plastic flap and remove the grub screws from the bottom of the cavities with the allen key provided. Remove any excess body filler from the bottom of the cavities. Screw the brass mounting studs into the threaded holes, and tighten lightly with a flat-bladed screw driver.

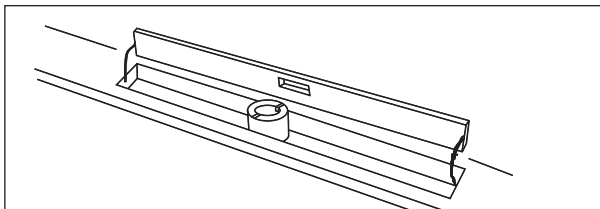

- 2** Install each pad into each cavity, ensuring that the plastic flap is folded right up and the curved portion of the pad's top recess is towards the outside of the vehicle.

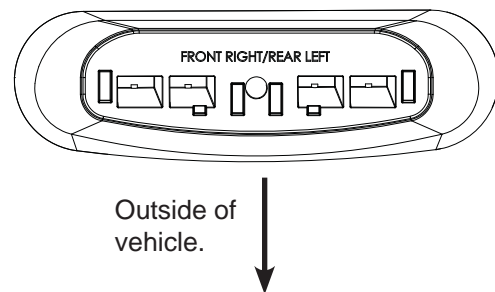

- 3** Place the crossbars onto the corresponding pads. Assemble the spring washers and the flat washers onto the screws, slipping the spring washer on first. Insert the hex setscrews into the support leg mounting holes and screw down into the brass mounting studs under the pads. **NOTE:** The shorter **35mm screws** go into the **centre** pads and the longer **50mm screws** go into the **front and rear pads**. Do not over-tighten. When crossbars are not in use, remove and install the cover plates provided using an M6 x 50mm screw, M6 spring washer and flat washer.

