

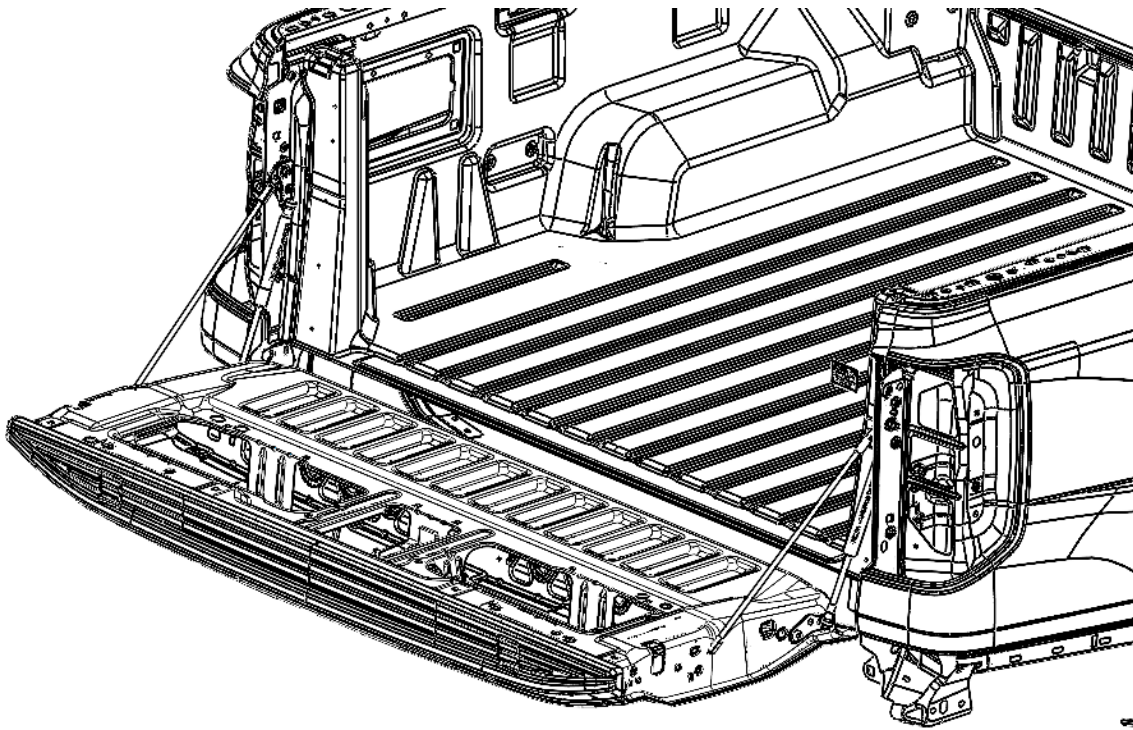

# FITTING INSTRUCTIONS

## 4740060 TAILGATE ASSIST KIT TO SUIT FORD RANGER MY22+ WITH ARB CANOPY (With OE tailgate torsion bar)

## 4740070 TAILGATE ASSIST KIT TO SUIT FORD RANGER MY22+ WITHOUT ARB CANOPY (With OE tailgate torsion bar)



4740060 – WITH ARB CANOPY  
4740070 – WITHOUT ARB CANOPY

### **IMPORTANT**

- ◆ If being fitted to a vehicle without the OE torsion bar fitted to the bottom of the tailgate, the OE torsion bar part must be fitted prior to Tailgate Assist fitment.
- ◆ This product must be installed exactly as per these instructions using only the hardware supplied.
- ◆ Failure to follow instructions precisely may lead to failure of the product or result in injury if the gas spring extension clip is removed prior to the gas spring being fitted.
- ◆ The installation of this product may require the use of specialized tools and/or techniques.
- ◆ During installation, it is the duty of the installer to check correct operation/clearances of all components.
- ◆ Work safely at all times.
- ◆ Specific installation can vary, so please read the following instructions as they refer to important information, which could affect the quality of the final installation.

- ◆ It is advisable to have these parts fitted by an authorised dealer.
- ◆ **Ensuring that the specified torques are used as contained in this fitting instruction is imperative, as failure may occur.**
- ◆ IF IN DOUBT CONTACT ARB FOR FURTHER INSTRUCTION.

**HAVE AVAILABLE THESE SAFETY ITEMS WHEN FITTING PRODUCT:**

Protective eyewear		Hearing protection		Gloves	
--------------------	---	--------------------	--	--------	---

*NOTE: 'WARNING' notes in the fitting procedure relate to OHS situations, where to avoid a potentially hazardous situation it is suggested that protective safety gear be worn or a safe work procedure be employed. If these notes and warnings are not heeded, injury may result.*

**CARE INSTRUCTIONS:**

In general, the Tailgate Assist system is maintenance free with no need for regular attention. However, the following should be noted: -

- ◆ Gas tension spring struts are open systems. As such, avoid allowing dirt or other particles get into the gas spring through the ventilation hole in the cylinder end.
- ◆ When cleaning, use a non-caustic soap and avoid aiming high pressure water jets into the seal area. Clean with a damp cloth.
- ◆ If grinding noises come from the ball sockets, remove the ball sockets (being careful not to lose or damage the clip) and clean any grit from the ball socket and ball.
- ◆ Avoid excessive heat (greater than 80°C).
- ◆ DO NOT grip piston rods on dampers or gas springs with pliers, vice grip or similar (avoid scratching, denting or bending the rod). Damaged piston rods cause damage to seals and the product will not perform as intended.
- ◆ Avoid paint overspray, weld or grinding splatter, or materials such as glue, or concrete splatter.
- ◆ Avoid cleaning products that leave a coating such as silicones.
- ◆ Avoid applying adhesive tape to the piston rod and do not tie anything to the damper of gas spring as this will lead to bent piston rods.
- ◆ Orientation of installation must be with the cylinder end up of both the gas spring and the damper.

**TOOL LIST FOR FITMENT:**

<ul style="list-style-type: none"> <li>• Torque Wrench</li> <li>• Socket driver &amp; 17mm socket</li> <li>• Torx drive socket bits T30, T40</li> </ul>	<ul style="list-style-type: none"> <li>• Socket drive</li> </ul>
---	--

**!! IMPORTANT !!**

**REQUIRED SCREW TORQUES: Refer to steps in fitting instruction**

**Screw torques must be adhered to. Over torqueing can cause failure of components.**

## IMPORTANT NOTE:





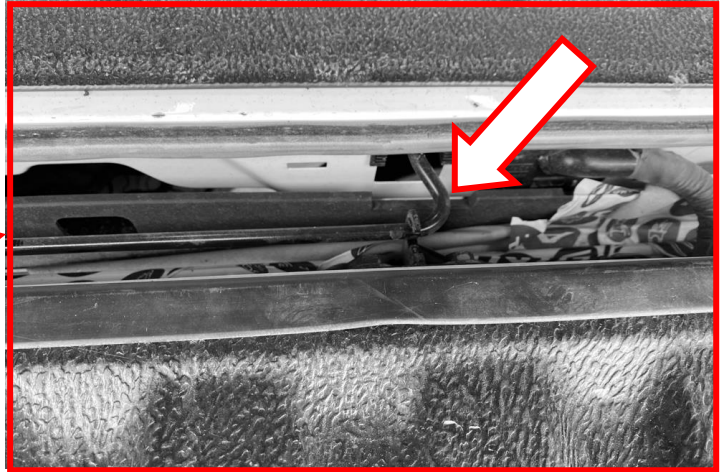
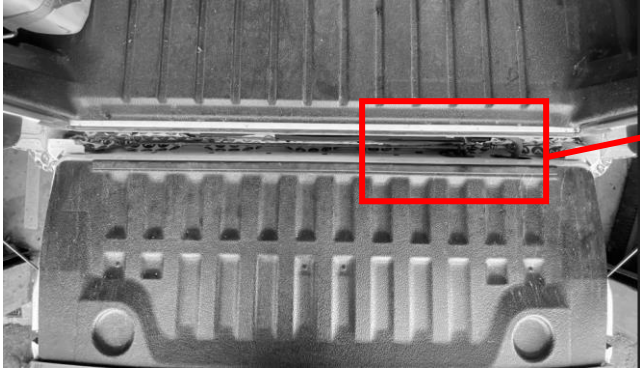





Before installing ARB Tailgate Assist kit, ensure that the intended vehicle is fitted with an OE Torsion bar from Ford, as shown below. If the OE torsion bar is not present, the purchase and installation of OE torsion bar is required prior to ARB tailgate assist kit installation.



Please consult your OE supplier for kit purchase and installation.

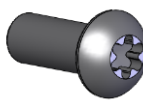

## THE FITTING KIT CONTAINS:

KIT	Part No	Picture	Qty	Description
Box Kit: 4740060 4740070	3753565		1	BALL STUD BRACKET UPPER- LH
	3753554		1	BALL STUD BRACKET UPPER - RH
	3753556L		1	WIRE STAY KEEPER BRACKET UPPER - LH
	3753556R		1	WIRE STAY KEEPER BRACKET UPPER - RH
	3195568		2	SPACER BRACKET - MIDDLE UPPER

USED ONLY IN KIT 4740060	4590031			DAMPENING STRUT
USED ONLY IN KIT 4740070	4590029			DAMPENING STRUT
	4950028			GAS SPRING
<b>Bagged Kit: 6177841</b>	6152030		2	M10 PIVOT BALL DIA 10
	4590029		1	DAMPENING STRUT
	4950028		1	GAS SPRING
	4584328		4	M8 x 19 x 1.2MM THICK FLAT WASHER
	6151881		2	M8 x 35 TORX HEAD SCREW
	5848468		2	12MM O.D. x 8.2 I.D. x 4MM THICK SPACER
	6151711		2	M6 x 25 TORX HEAD SCREW
	4584327		2	M6 x 16 x 1.2MM THICK FLAT WASHER

	2125702		1	WARNING LABEL
	6602018		1	ALCHOL SWAB SINGLE SACHET
	2125725		3 Pair	CLEAR ABRASION RESISTANT STICKER 3 BAGS, 2 PER BAG (6 TOTAL)

**SECTION 1: REMOVE COMPONENTS ON LHS, ONE SIDE AT A TIME.**

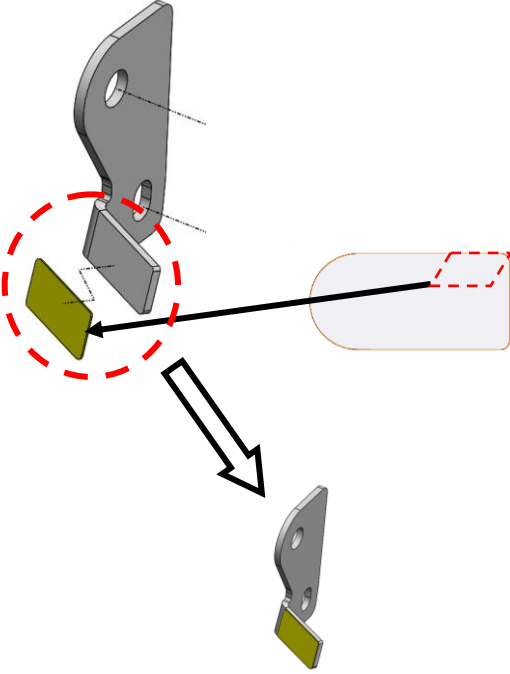
Section1: FITTING LHS DAMPENER	
	<p>1.0) Use an alcohol wipe (6602018) to clean the outward facing tab faces of (3753556R/L) wire stay keeper brackets as shown.</p> <p>Cut a piece from a single piece of (2125725) clear abrasions resistant sticker to suit the outward facing tab faces of (3753556R/L) wire stay keeper brackets as shown. Ensure that piece does not hang over the edges of the bracket tabs.</p>

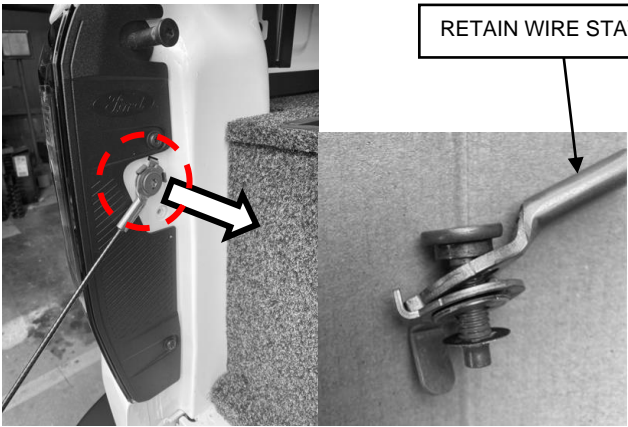
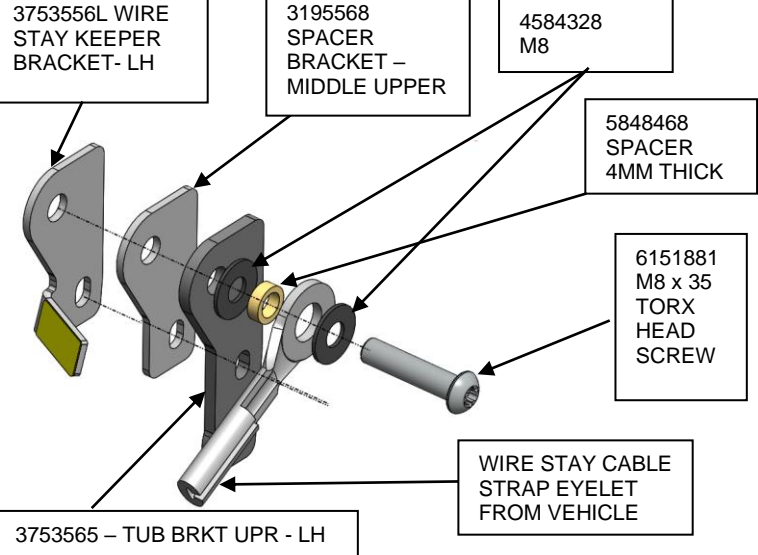
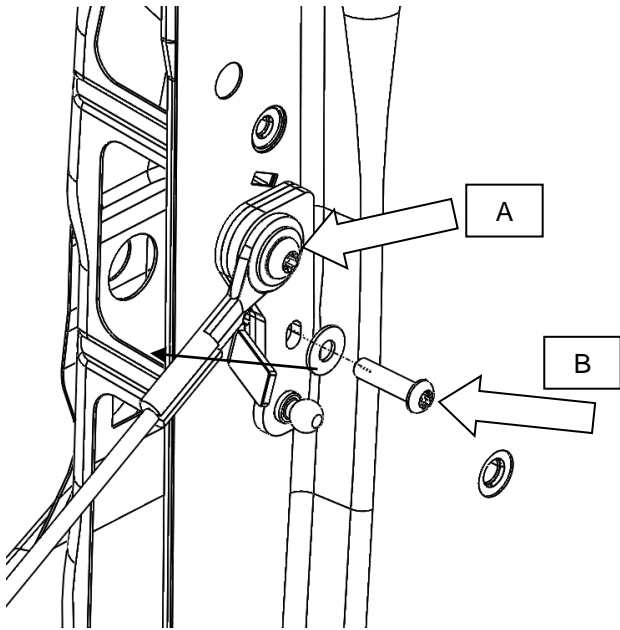
	<p>1.1) Remove Fastening hardware that retains wire stay between the tub and the tailgate on left-hand side of tub. Discard all fasteners and retain wire stay only.</p>
	<p>1.2) As shown for the left-hand assembly, retrieve all brackets, fasteners and components required for left-hand side as shown. Pre-assemble this as shown onto the M8 x 35 Torx head screw (6151881)</p>
	<p>1.3) Loosely fit the above assembly into position on the left side of tub at (A) and then fit the lower portion at (B) with an (6151711) M6x25 Torx screw with (4584327) M6 washer as shown.</p> <p>Once both positions are assembled, fasten both Torx screws to <b>correct torque:</b>  <b>M6 bolts to 9Nm.</b>  <b>M8 bolts to 20Nm.</b></p>

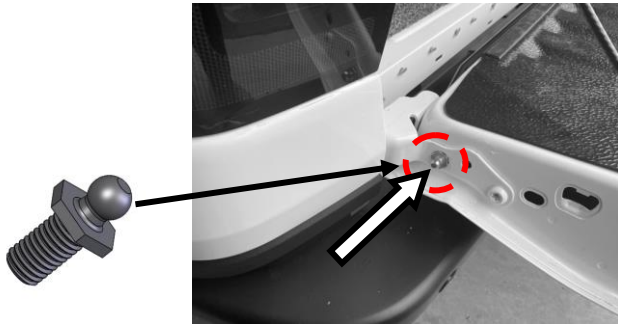
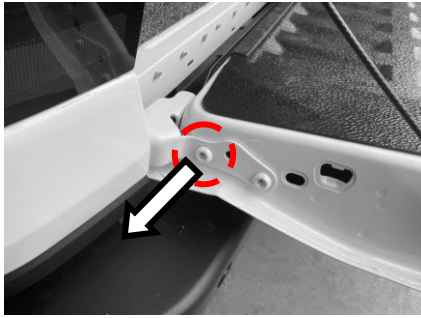

6152030

- 1.4) Remove M10 Torx bolt from the lower hinge bracket on the tailgate and replace it with M10 pivot ball (6152030) in kit. With a 17mm socket, fasten the pivot ball to required **Torque of 40Nm**.

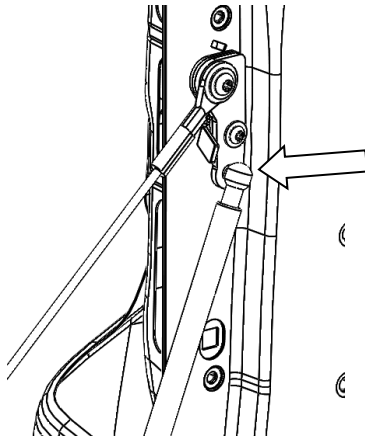

- 1.5) Fit the Dampener (4590031 for Vehicle fitted with ARB Canopy installed or 4590029 for Vehicle without ARB Canopy installed) **with the cylinder body at the top** to the upper ball stud to left-hand side of the vehicle's tub.

## Section2: FITTING RHS ASSIST – GAS SPRING

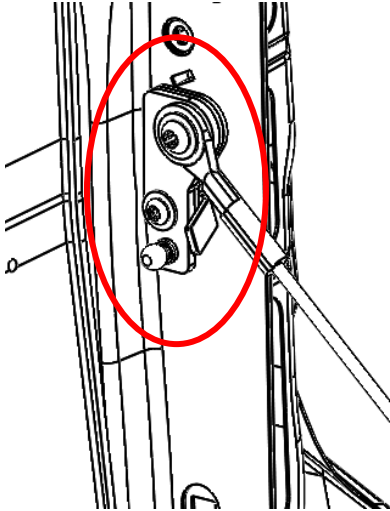

2.0) Repeat steps 1.0 through to 1.4 for the right-hand side of vehicle using right-hand bracketry components.

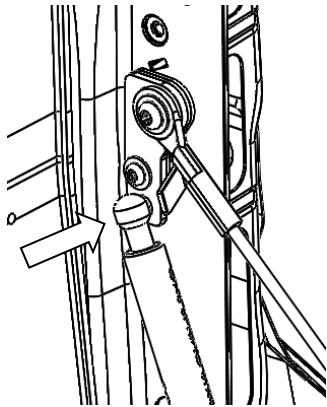

2.1) Fit the (4590028) gas retraction spring **with the cylinder end up** to the upper ball stud to RHS of tub.

**Note: Warning** Gas Spring is **under pressure**, care should be taken when installing it **not to dislodge the extension spacer on the rod**.

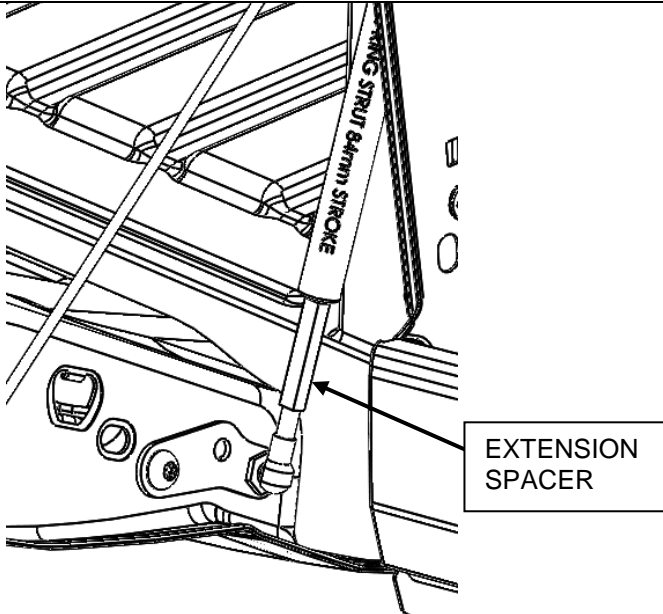

**Note: Warning** Gas Spring is **under pressure**, care should be taken when installing it.



2.2) Fit the lower end of the gas retraction spring to the tailgate pivot ball by lifting the tailgate up to gain alignment between the ball stud and ball socket; **ensuring to be careful not dislodge extension spacer on the gas spring when connecting them to avoid damage and or injury.**

2.3) Once connected, lower the tailgate down and discard the extension spacer (the small aluminium extrusion that is clipped around the rod).





2.5) Clean the indicated surface on the tub with an (6602018) alcohol wipe at the rear of the tub. Apply warning label (2125702) to the area indicated. The label is to sit above the gas retraction spring on the right-hand side of vehicle, as shown.

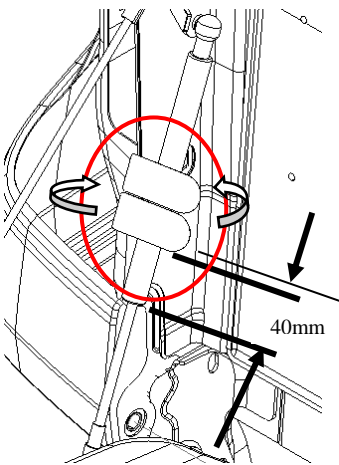

LHS

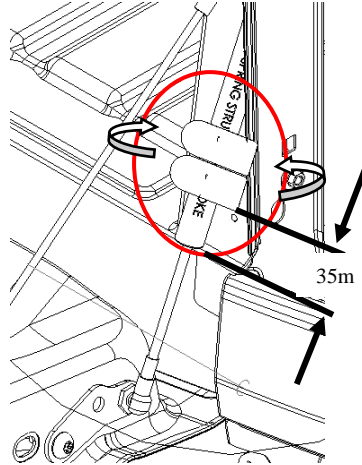

RHS

2.6) Clean the cylinder bodies of the gas spring and dampener struts with an (6602018) alcohol wipe. Take (2125725) clear abrasion resistant stickers and apply two on both the Gas spring (RHS) and Dampener (LHS), wrapping it around the diameter of each strut as shown in the area where the wire stay cables contact them during closing.



2.7) Re-check all newly installed fasteners, upper and lower pivot ball attachments are properly secured.

2.8) Test tailgate assist to ensure it is working correctly.

2.9) Make sure there is no binding, cables protruding from the gap between the vehicle's tub and the tailgate, and ensure there is no contact of the struts to the tailgate or vehicle body.