

INSTALLATION MANUAL

Product: **Front bumper**
Model: **NISSAN NAVARA (2015-on)**
Part No: **2D.4101.1**



CAUTION!

To reduce the risk of serious injury or damage, please read and understand all instructions and procedures before attempting to install or use this product.

Safety glasses must be worn at all times during installation or maintenance of this product.

Ensure all mounting bolts are tensioned after 1000 kms and periodically there after.

NOTICE

Whilst the bumper adds additional protection to your vehicle, precautionary measures still need to be taken to avoid damage.

Always drive to the conditions and your surroundings.

Front Bumper for Nissan Navara

Part No:	2D.4101.1
Brand:	Nissan
Model:	Navara
Year:	2015-
Material:	Aluminum 6 mm
Dimensions:	859x580x644mm
Weight:	40kg
Compatibility:	2333.4164.2/6 RIVAL Underbody armor



Safety Notice

- * The RIVAL Bumper is designed to compliment the use and design of the specified vehicle under conditions specified by the car manufacturer.
- * While driving the vehicle at any speed, collision with any other vehicle, animal or object must always be avoided.
- * Following any collision with any other vehicle, animal or object, the RIVAL Bumper and the vehicle must be inspected by a specialized or suitably qualified vehicle repairer for possible damage to the components and assemblies in order to confirm suitability for further use of the vehicle.
- * It is strongly recommended that you do not operate a vehicle with a damaged bumper or its components. In the case of damage, please contact the nearest RIVAL dealer.
- * The operation of a vehicle where the bumper is not properly attached and fastened to the vehicle, or where the bumper has been damaged, is extremely dangerous and must be avoided at all cost.

Installation Notice

- * The RIVAL Bumper must be mounted and affixed to the vehicle according to this installation manual.
- * Personal safety during the installation process must be adhered to at all times and the use of personal safety equipment is highly recommended.

Required Tools

- * Basic tool kit
- * Electric drill
- * Angle grinder
- * Drill set
- * Torque wrench
- * Box knife
- * Marker

Torque Setting

* M6	9 Nm
* M10	44 Nm
* M12	77 Nm

*Winch installation

A winch with a pull capacity of up to 12000 lb can be installed with the RIVAL Bumper. It is not advisable to exceed this pulling capacity since damage, injury or death may occur where the 12000lb recommended capacity is exceeded. There is a special license plate holder supplied with the bumper which will provide access to the winch.

Winch measurements:

254x114,3 mm.

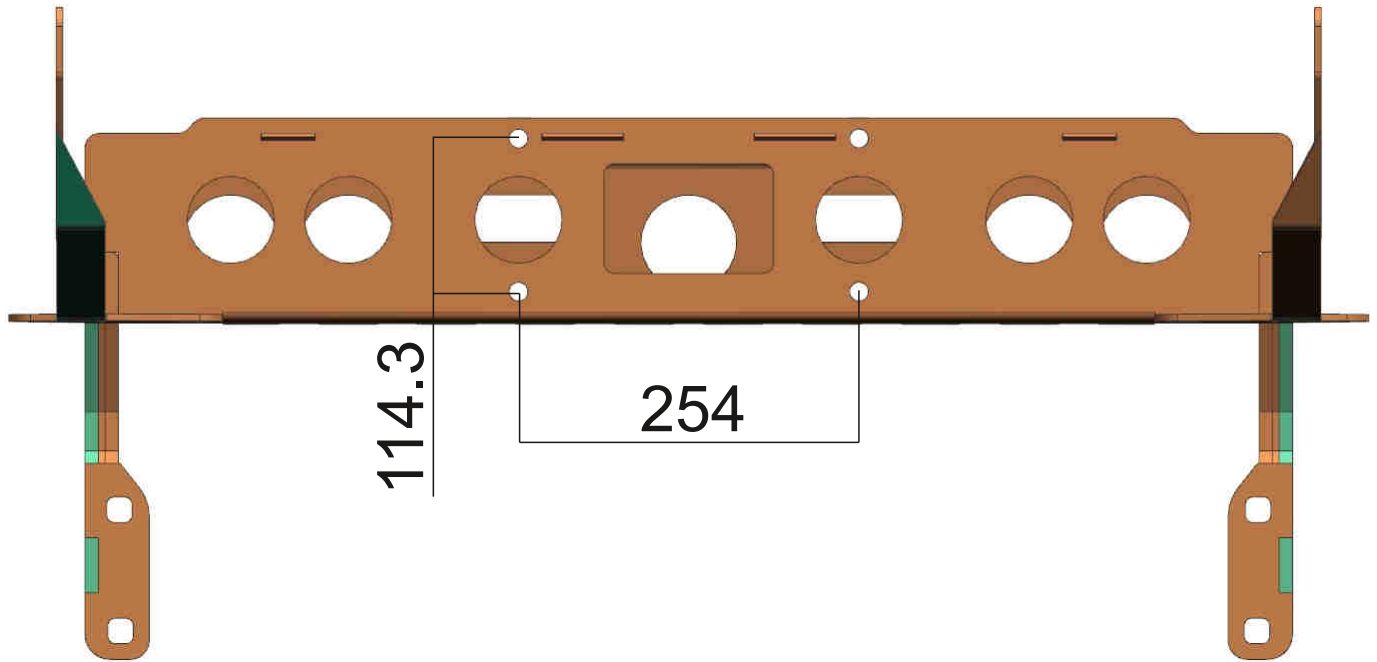

1. Aluminum bumper body.....	1 pc.	14. LED cap.....	2 pcs.
2. Bumper bracket.....	1 pc.	15. Plastic cap.....	2 pcs.
3. Chassis spacer.....	2 pcs.	16. Bolt 6x16.....	2 pcs.
4. Seal holder 1.....	2 pcs.	17. Screw 6x20.....	20 pcs.
5. Seal holder 2.....	2 pcs.	18. Countersunk Screw 10x30.....	11 pcs.
6. LED Bracket.....	2 pcs.	19. Bolt 12x1,25x30.....	4 pcs.
7. LED.....	2 pcs.	20. Bolt 12x1,25x40.....	2 pcs.
8. Flap.....	2 pcs.	22. Nut 12x1,25.....	4 pcs.
9. License plate holder.....	1 pc.	22. Nut 10.....	8 pcs.
10. Insert Nut M10.....	1 pc.	23. U-nut 6.....	10 pcs.
11. Insert Nut M12.....	1 pc.	24. Nut 6.....	2 pcs.
12. Plastic Cap.....	1 pc.	25. Washer 12.....	10 pcs.
13. Countesunk washer.....	11 pcs.	26. Washer 10.....	8 pcs.
		27. Washer 6.....	20 pcs.
		28. Seal.....	1,5 m

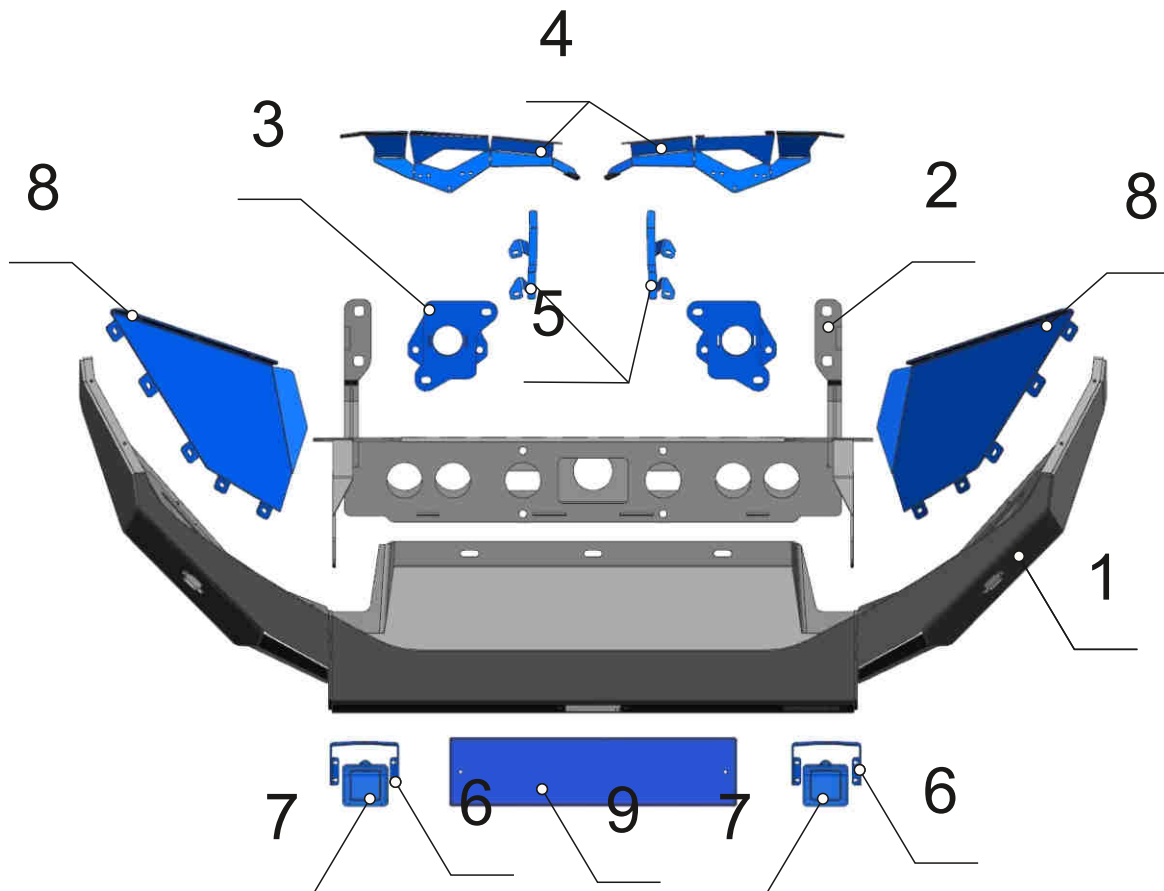



1. Open the bonnet.
2. Disconnect the negative battery terminal cable.



3. Remove caps of grille mount in upper side.



4. Remove caps of grille mount from left and right side.



5. Disconnect the front camera.

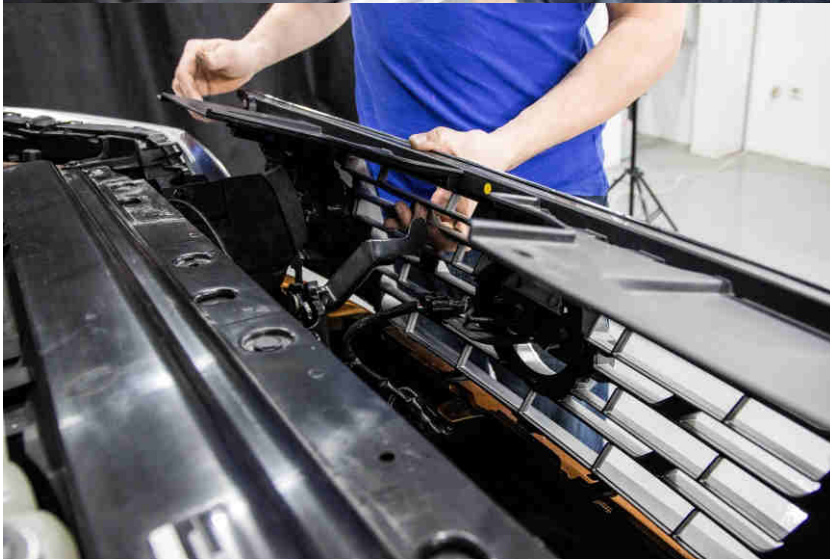

6. Carefully remove grille.

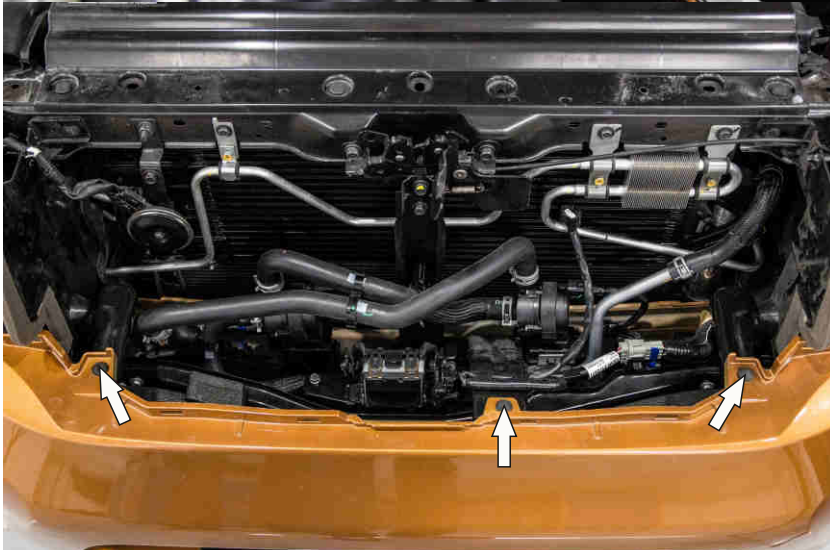

7. Remove caps of bumper mount.



8. Remove 2 screws from inside of the fenders on each side of the vehicle.



9. Remove 4 bolts. Remove central part of lower lip.



10. Remove 2 bolts of lower lip mount on each side.

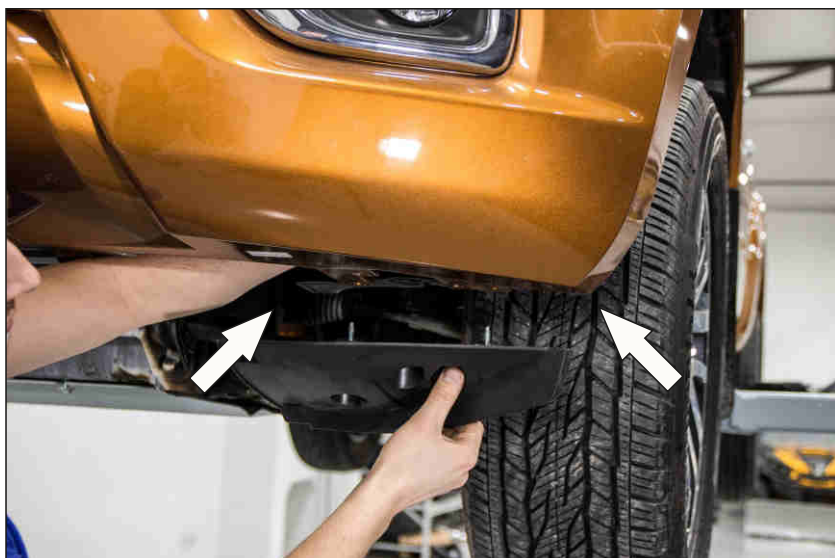

11. Remove 2 nuts from inside of the bumper. Remove side part of the lip.

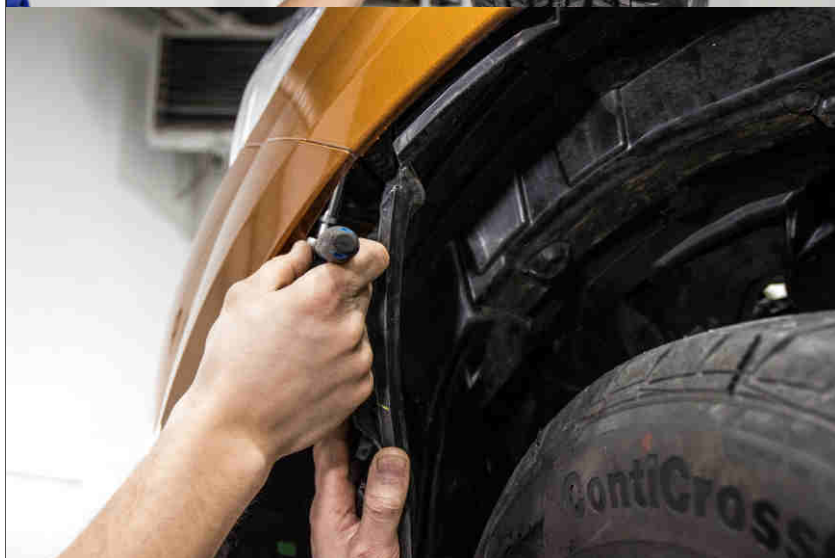

12. Carefully peel back plastic fenders and remove screws of bumper mount on each side.

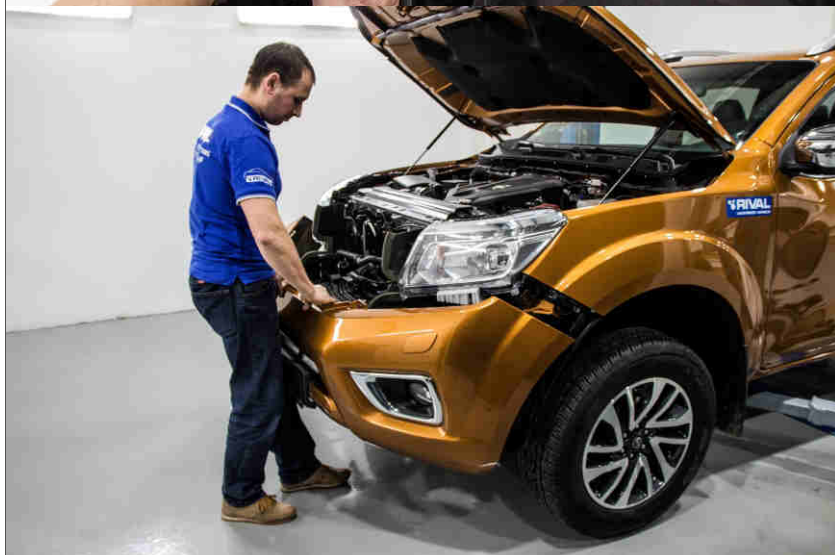

13. Remove the bumper by pulling the bumper towards you holding the sides.
14. Disconnect the hose from the headlight washer and the connectors for the lights.

**Ensure the washer fluid tank is empty.*

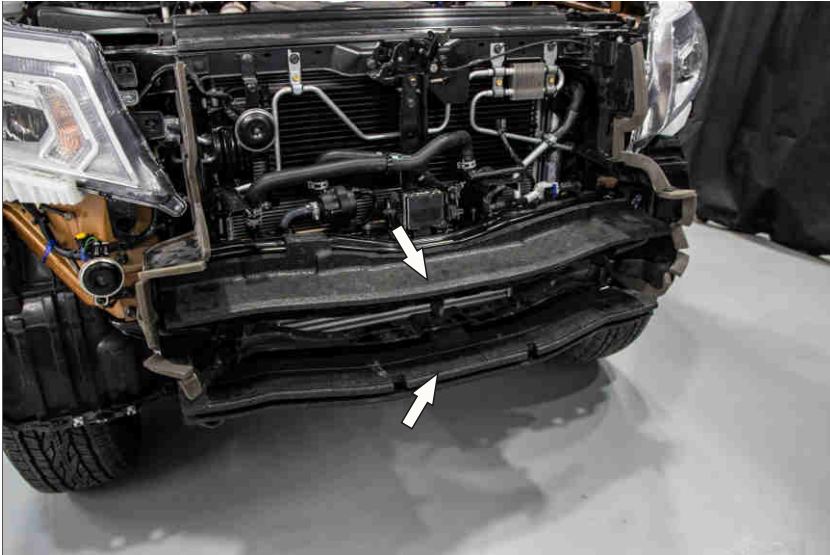

15. Remove dampers.

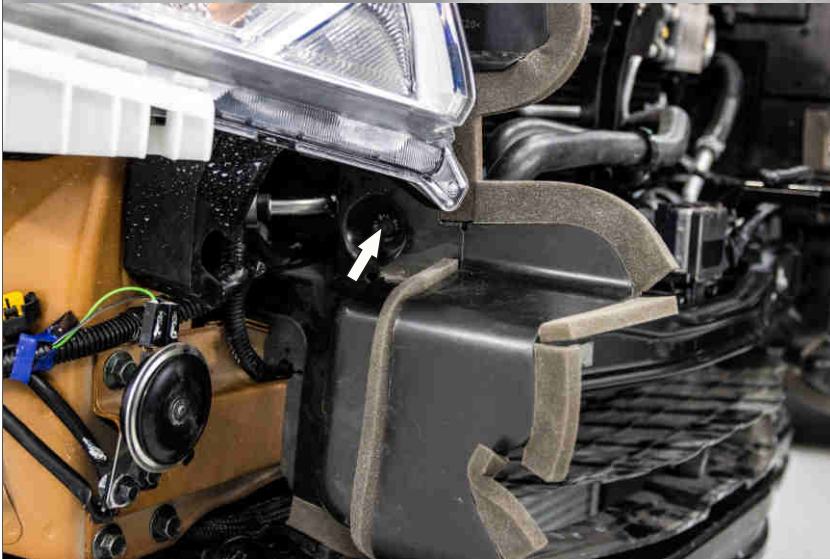

16. Remove caps of plastic dust covers mount.



17. Remove plastic dust covers on each side.

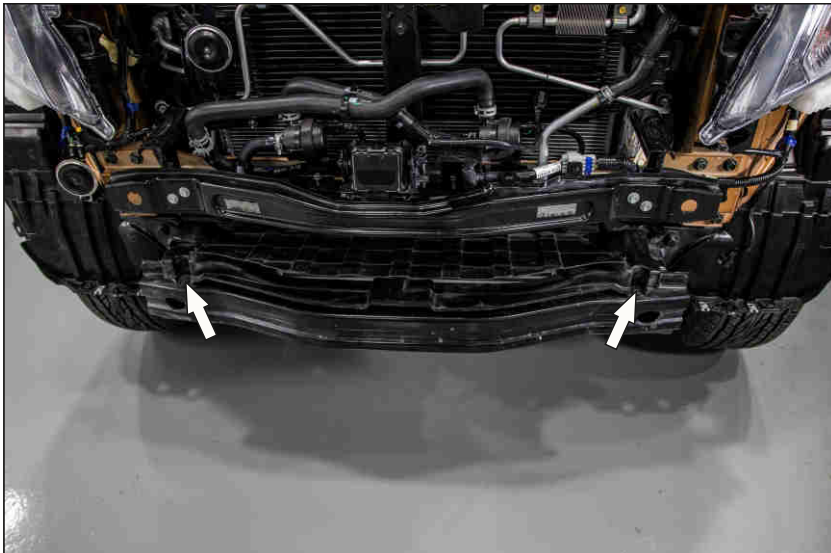

18. Remove caps of air intake mount. Remove air intake.

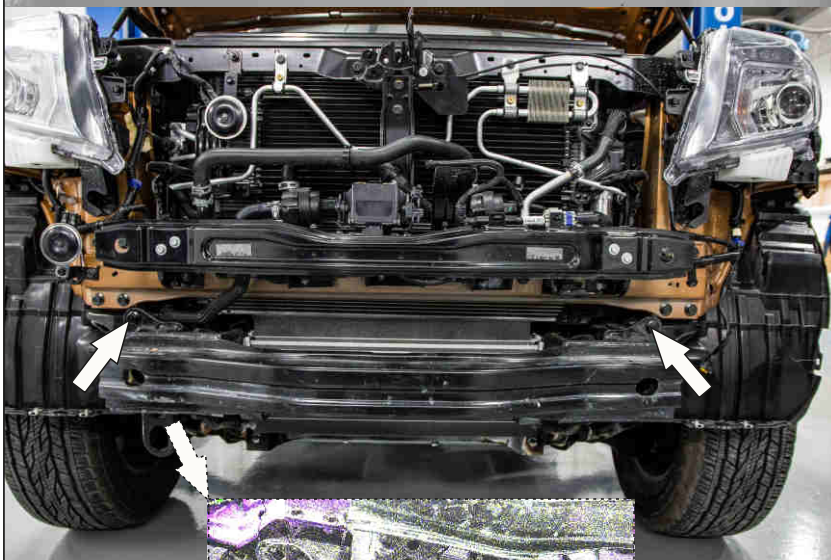

19. Remove 4 bolts of chassis amplifier mount. Remove chassis amplifier.

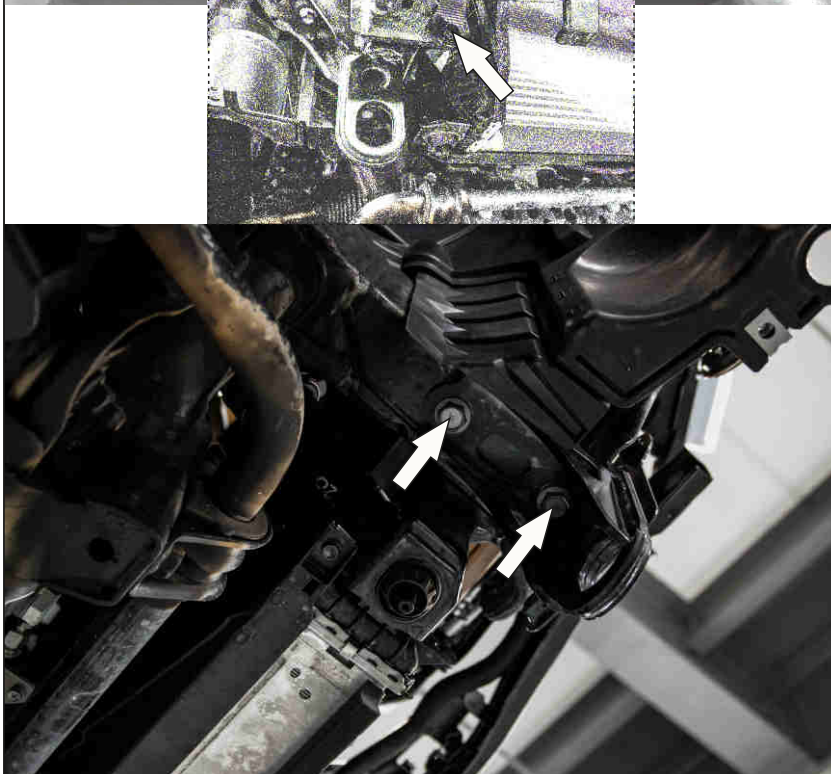

20. Remove 2 bolts. Remove OE towing hook.



21. Remove screws. Remove plastic holders.

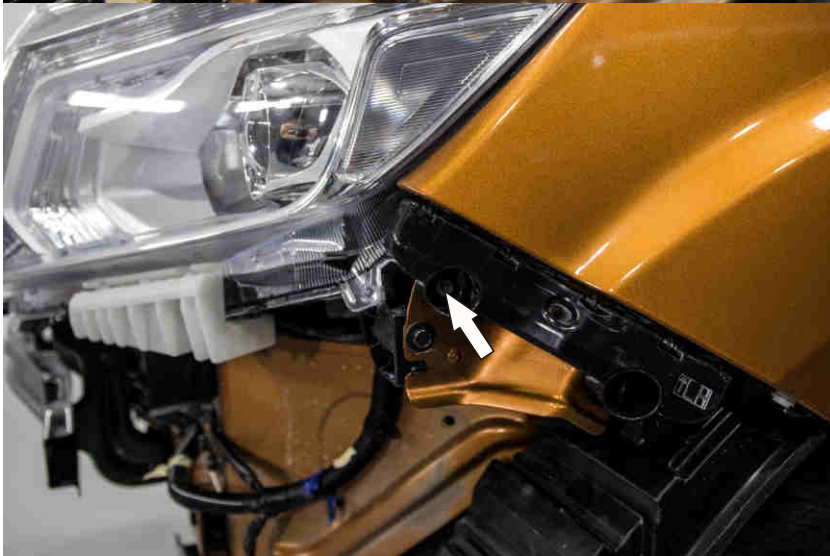

22. Remove screw. Remove holders.



23. Remove bolts of headlight mount.



24. Cut seals (28) on parts with length 260mm and 490mm for left and right side of vehicle.
25. Put 490mm seals on brackets (4).



26. Mount brackets (4) on vehicle using OE fittings. Align bracket with seals. Bend the brackets if necessary



27. Put 260mm seals on brackets (5).
28. Mount brackets (5) using screws(17), nuts M6(24) and washers M6 (26).

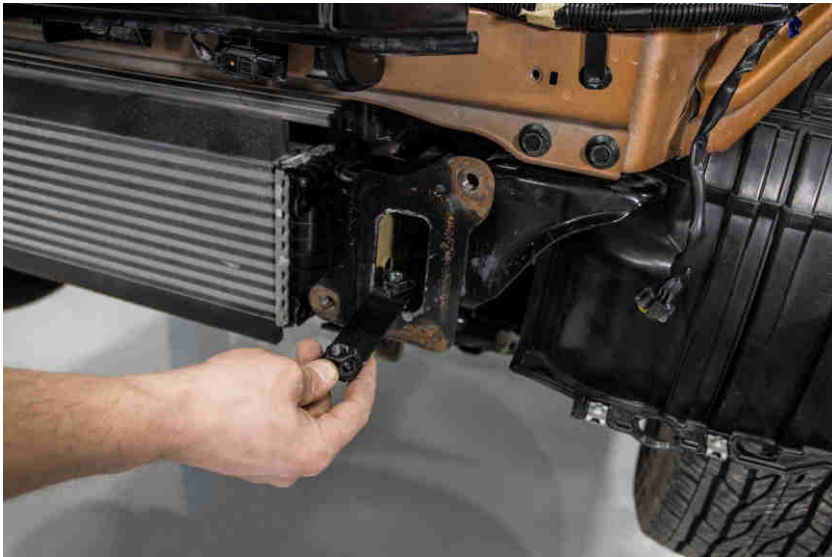

29. Mount inside nut M12x1,25(11) into the chassis from the left side of vehicle.



30. Mount spacers (3) on chassis from each side using OE fittings. Do not tighten yet.

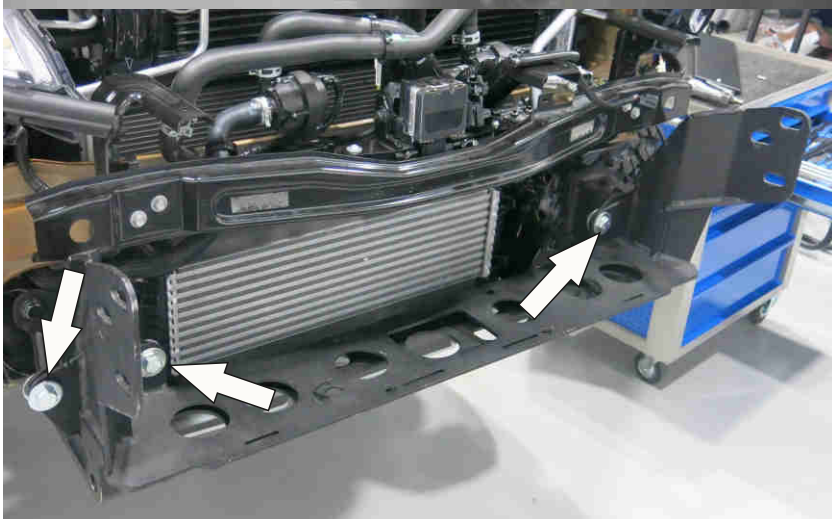

31. Mount winch bracket on spacers using bolts M12x1,25x30, nuts M12x1,25 and washers 12. Do not tighten yet.

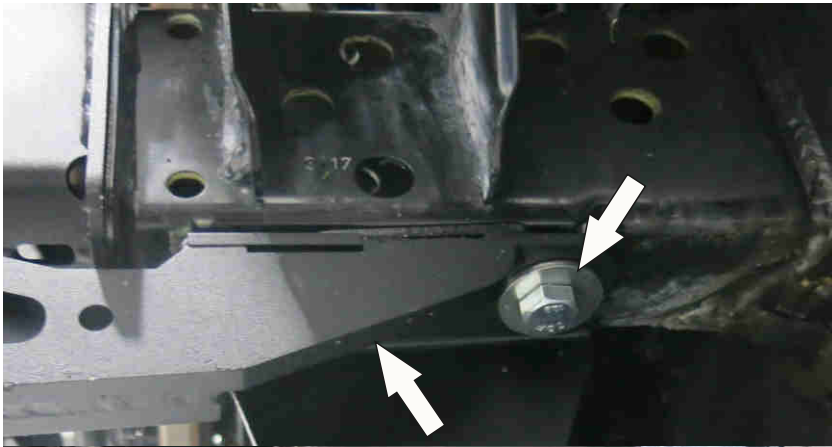

32. Mount lower part of bracket from the left side using bolts M12x1,25x40 and washers 12.



33. Mount lower part of bracket from the right side using OE bolts of towing hook fitting.

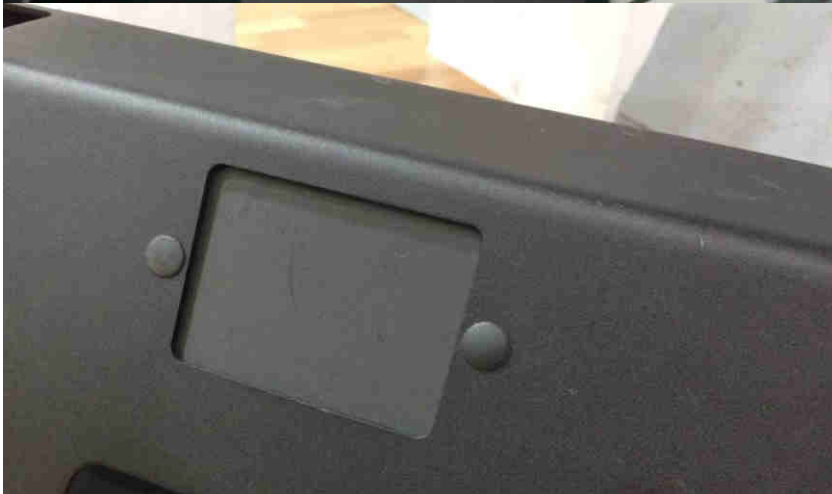

34. Mount plastic cap(20) on bumper body(1) using caps (43).



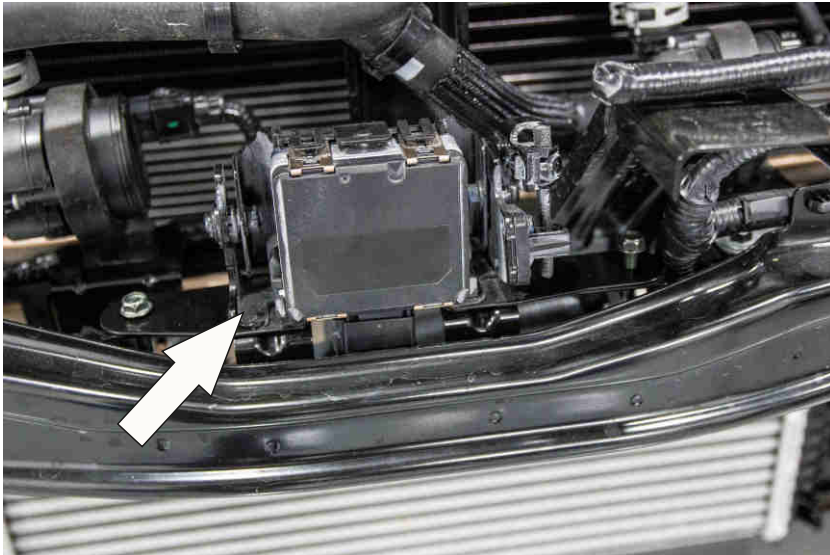

**For vehicles with radar*

35. Remove radar.



**For vehicles with radar*

36. Mount radar on bumper body (1), using bolts M6x16(16), nuts M6 (27) and washers M6.



**depending on the delivery*

37. Mount LED brackets using screws M6x20 and washers 6. Align the position.

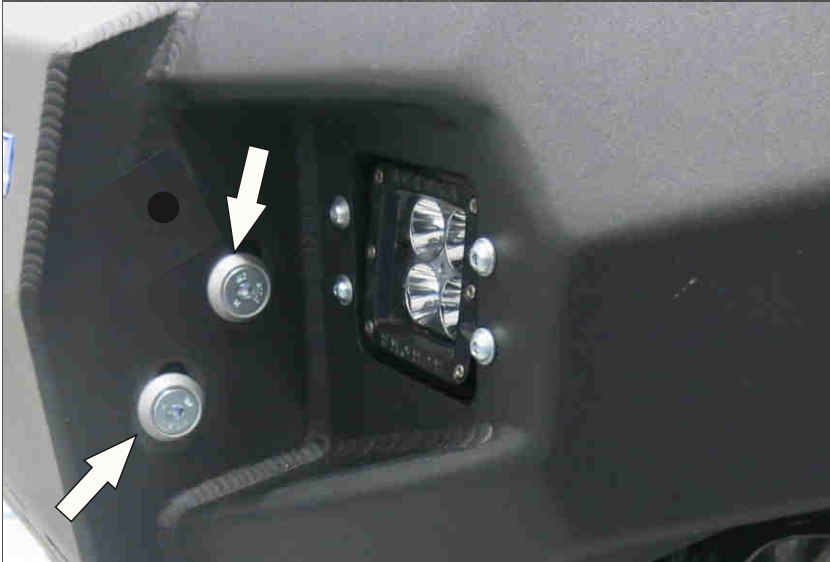

**depending on the delivery*

38. Mount bumper body on bracket using screws M10x30, nuts M10, insert nuts 10, washers 10. Do not tighten yet.

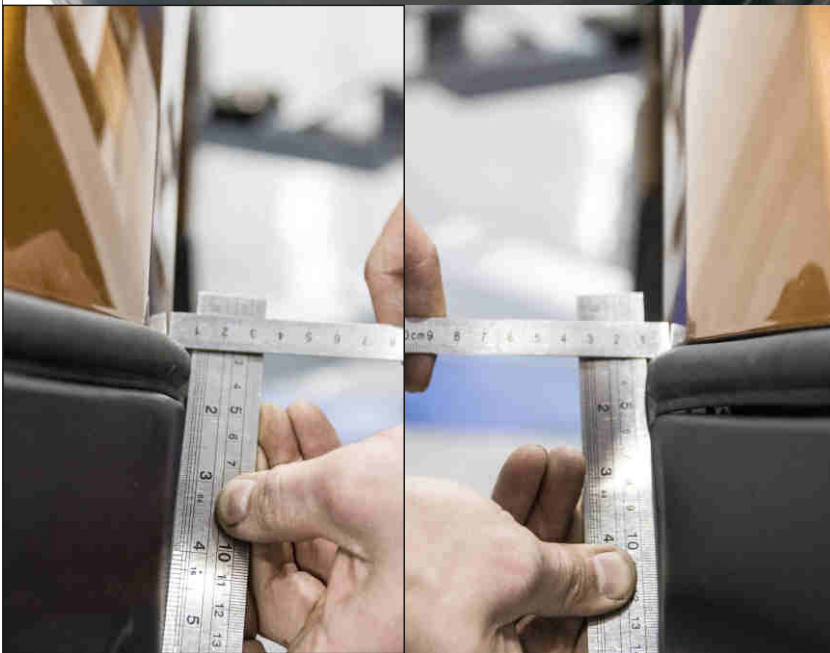

39. Align the bumper.
40. Tighten all screws starting with spacers (3) and bracket (2) ending with screws on bumper body



41. Cut the seals

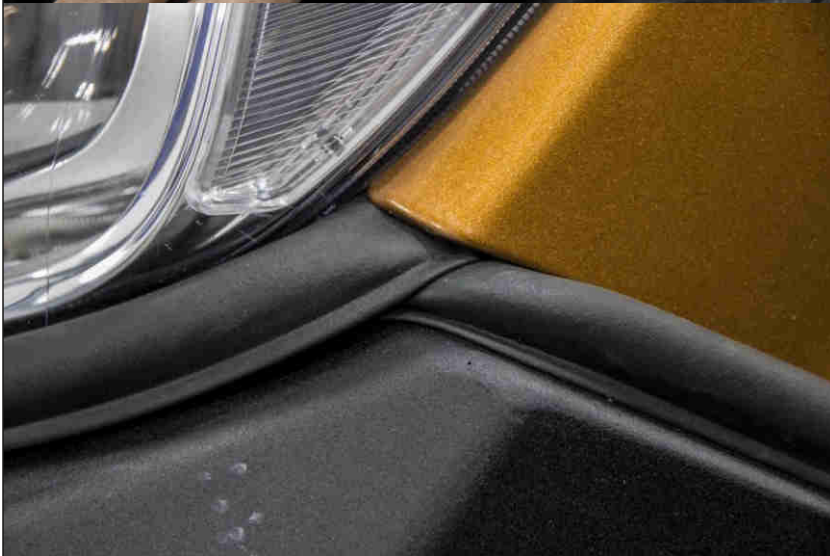

42. Bend the seals



43. Drill 10mm holes in winch bracket through the holes in bumper.



44. Fix bracket and bumper body through drilled hole using screws M10x30, nuts M10, countersunk washers 10, washers 10.



45. Drill 10mm holes in lower part of bracket through drilled holes. Mount bumper body on bracket using screws M10x30, nuts M10, countersunk washers 10, washers 10.

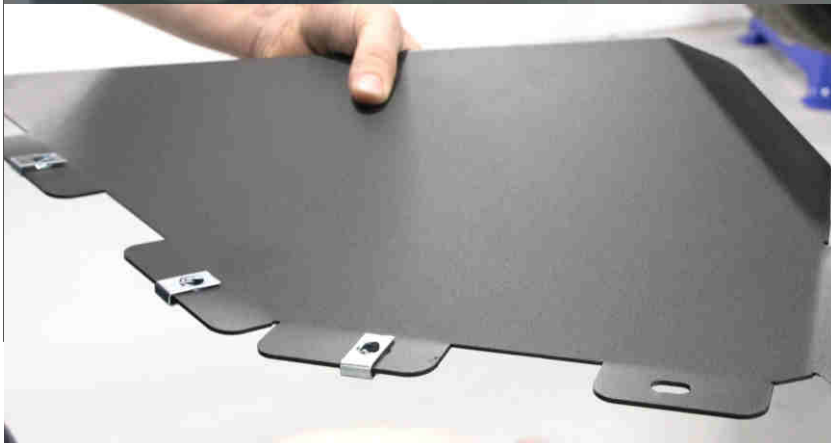

46. Mount u-nuts on flaps.



47. Mount flaps on bumper using screws M6x20 and washers 6.



48. Push the flaps to OE plastic fenders and mark the cut line.



49. Cut OE plastic fender.
*It's easier to cut plastic fender when the flaps are not installed.

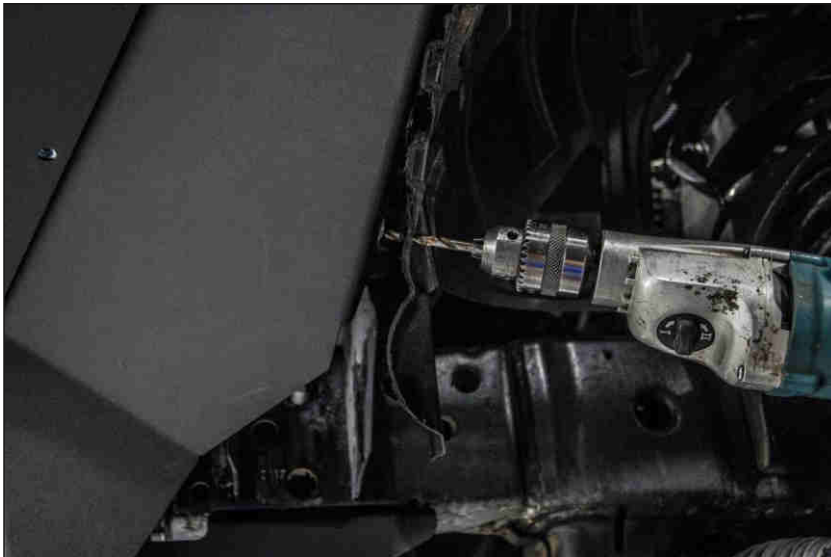

50. Mark a hole from inner side of the wheel fender from both left and right side of vehicle. Drill a 6 mm diameter hole..



51. Fix the flaps through these holes using bolts M6x20 (22) and washers

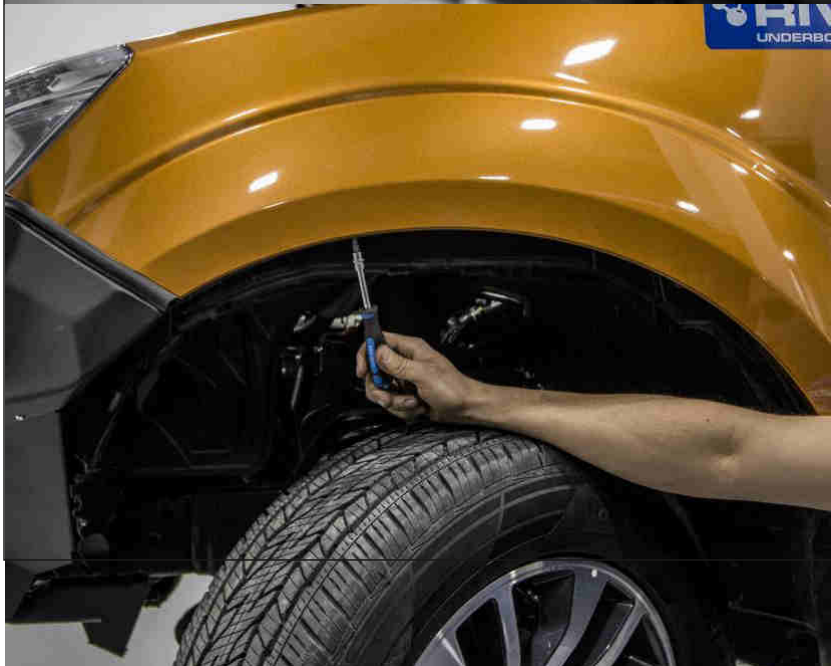

52. Screw in OE screws.



53. *Fix underbody armour to the bumper body using inside nuts, screws M10x30 and inside washers.

*Skid plate Rival 2333.4164.2/6 not included.

54. Mount grille.

Before operating a vehicle fitted with a RIVAL Bumper:

- make sure all fittings are tightened***
- check winch operation***
- check all electrical wiring attached to lights***

