

1. Enlever le cache d'origine et percer la patte en plastique  
 Remove the original cover and drill the plastic tab

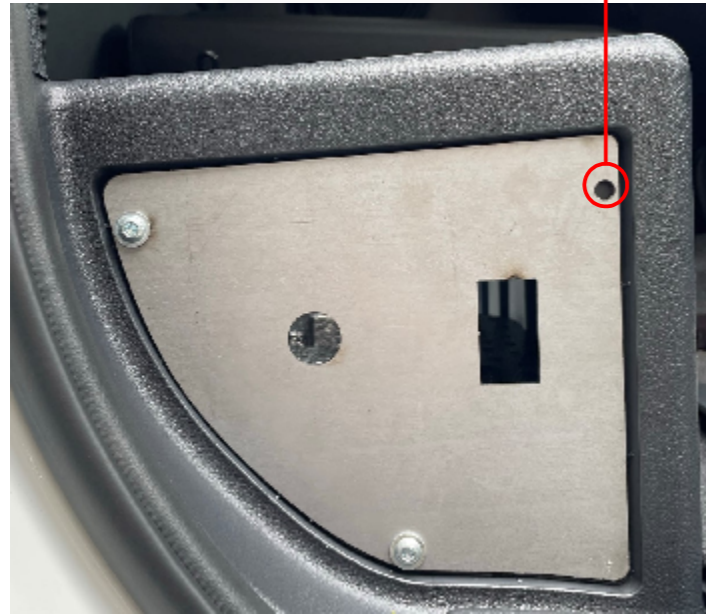

2. Positionner le raccord d'air et l'interrupteur  
 Install the air connection and the switch

Non fournis dans le kit de montage  
 Not included in the assembly kit

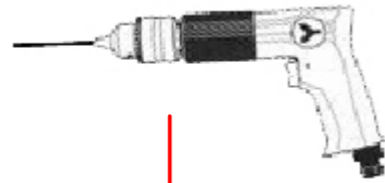
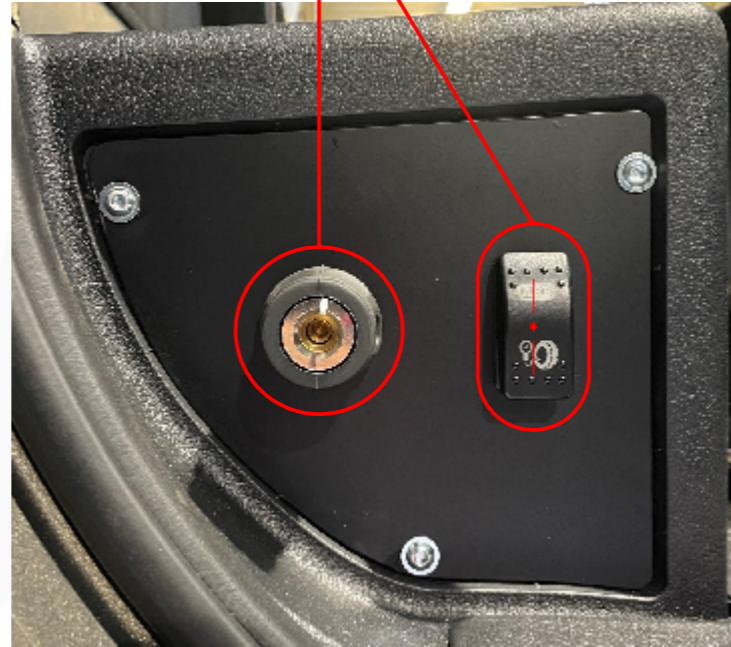

3. Fixer la plaque 1 et raccorder les éléments  
 Fix the plate 1 and connect the elements

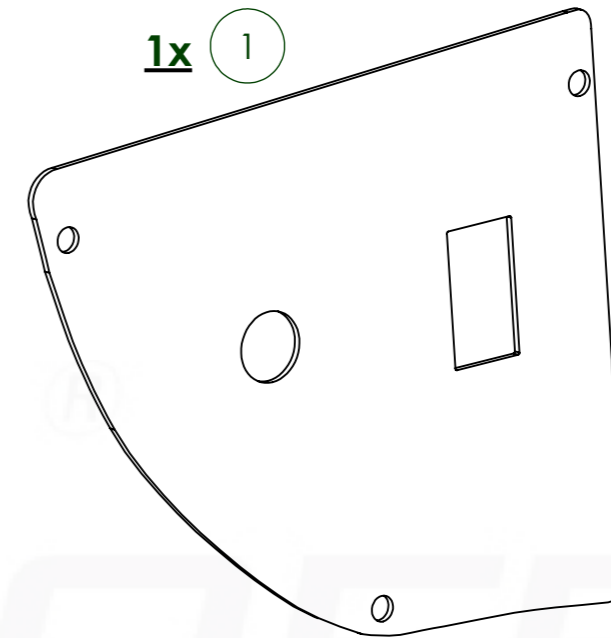
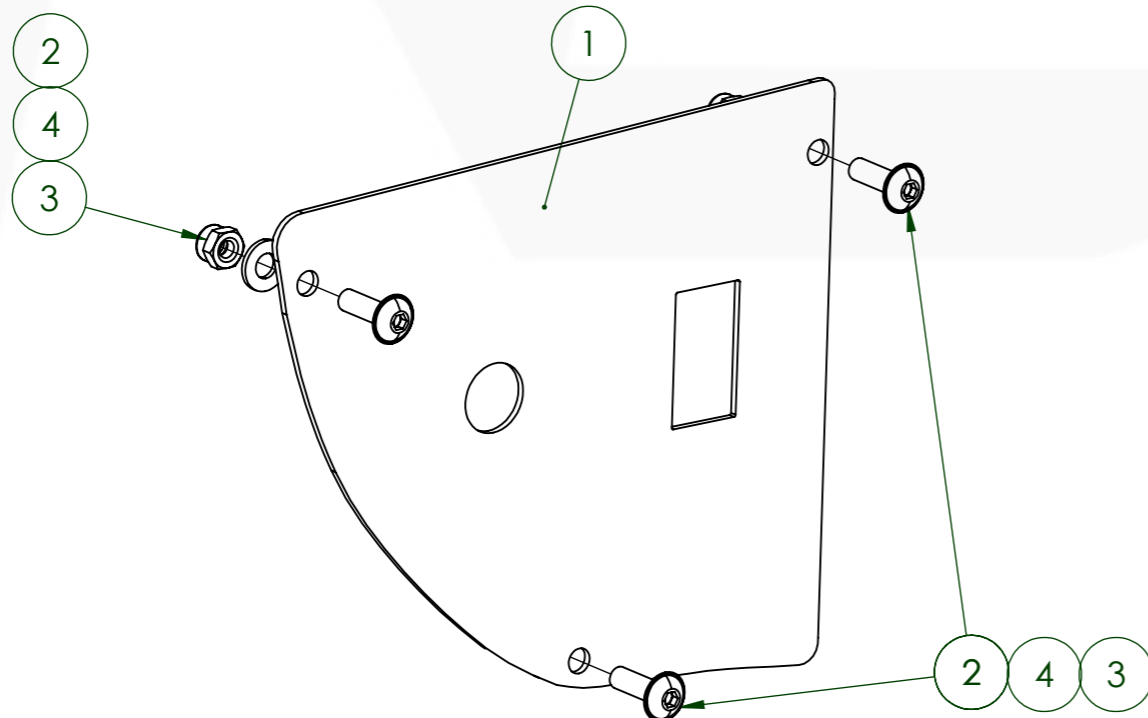

1x 1

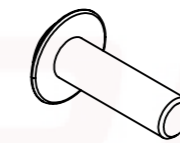

3x 3

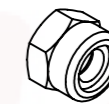

3x 4



Avant de procéder au montage, vérifier que le kit soit complet

Before fitting, check that the kit is complete

No. ARTICLE	NUMERO DE PIECE	DESCRIPTION	QTE
1	DVS124	Tôle / Plate	1
2	FOVCCBM6X25	Vis / Screws CBM6X25	3
3	FOVEM6S	Ecrou freiné / stop nut M6	3
4	FOVRM6	Rondelle / Washer M6	3

Application :

Kit montage support raccord / interrupteur  
 Mounting kit for connector / switch

TOYOTA HILUX > 2021

Plan propriété de la société DREAM TEAM CAR, ne peut être reproduit ni divulgué, même partiellement, sans notre accord écrit préalable.  
 Company ownership plan DREAM TEAM CAR, can not be reproduced or disclosed, even partially, without our prior written.

Réf. Kit :

**ERSU204K3**

feuille: 7 / 7

Ind: 00

Date : 25/04/2023



IMPORTANT: N4-OFFROAD dégage toute responsabilité de la bonne réalisation du montage des pièces. La personne qui réalise l'installation se déclare être compétente pour la réalisation de toutes les interventions nécessaires: positionnement, découpe, serrage, soudure...

CAUTION: N4-OFFROAD shall accept no liability with regard to the fitting of the parts. It is understood that the fitter has the necessary skills to fulfil all the tasks required to fit the parts: positioning, cutting, clamping, welding...

ATENCION: N4-OFFROAD declina toda responsabilidad por la correcta ejecución del montaje de las piezas. La persona que lleve a cabo la instalación se declara competente para realizar todas las intervenciones necesarias para la misma: colocación, corte, apriete, soldadura...

ATTENZIONE: N4-OFFROAD declina qualsiasi responsabilità in merito alla corretta realizzazione del montaggio dei pezzi. La persona che esegue l'installazione dichiara di essere in grado di effettuare tutti gli interventi necessari alla realizzazione: posizionamento, taglio, serraggio, saldatura...

ACHTUNG: N4-OFFROAD lehnt jede Verantwortung für die ordnungsgemäße Beendigung der Installation der Teile. Die Person, die die Installation ausführt erklärt verantwortlich für die Herstellung aller notwendigen Eingriffe: Positionierung, Schneiden, Klemmen, Schweißen ...