

FED LINER INSTALLATION MANUAL

FOR D/C SP/C S/C

1407

PART LISTS

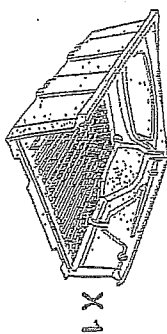

X1

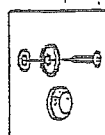

X4



OPTION

X2



X4 FOR D/C
X6 FOR SP/C, S/C

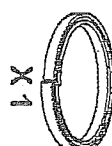

X1

TOOLS

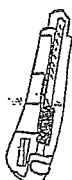

No.4

3

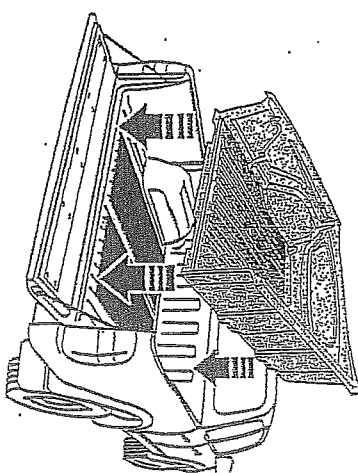

X4 FOR D/C
X6 FOR SP/C

2

OPTION



X2



X1

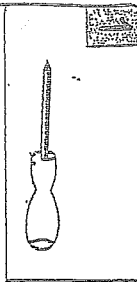
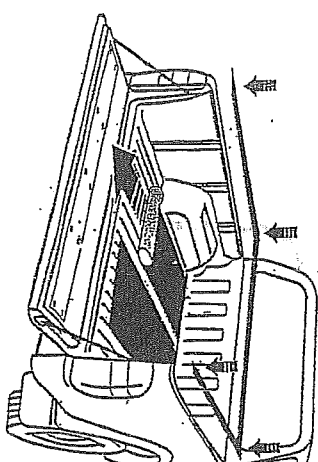

4

